



**World Mixed Curling Championship 2019
Aberdeen, Scotland**

12 – 19 October 2019

RESULTS SUMMARY



SAT 19 OCT 2019

Medallists

Medal	Country	Name	Gender
GOLD	CAN - Canada	KURZ Colin	M
		WALTER Meghan	F
		BILAWKA Brendan	M
		OLIVER Sara	F
		WAITE Jim	
SILVER	GER - Germany	KAPP Andy	M
		SCHOELL Pia-Lisa	F
		KAPP Benny	M
		TSCHETSCH Petra	F
BRONZE	NOR - Norway	NAESS Wilhelm	M
		SKAGA Ingvild	F
		SKARSHEIM RIAN Harald	M
		MESLOE Eirin	F
		RIAN Stale	

Legend:

F Female

M Male



Final Standings

Rank	Team	Players	Position - Function	Gender	Group Rank	DSC
Gold	CAN - Canada	KURZ Colin	4 S	M		
		WALTER Meghan	3 V	F		
		BILAWKA Brendan	2	M		
		OLIVER Sara	1	F		
		WAITE Jim	C	M		
Silver	GER - Germany	KAPP Andy	4 S	M		
		SCHOELL Pia-Lisa	3	F		
		KAPP Benny	2	M		
		TSCHETSCH Petra	1 V	F		
		-	C			
Bronze	NOR - Norway	NAESS Wilhelm	4 V	M		
		SKAGA Ingvild	3 S	F		
		SKARSHEIM RIAN Harald	2	M		
		MESLOE Eirin	1	F		
		RIAN Stale	C	M		
4	KOR - Korea	SEONG Yujin	4 S	M		
		JANG Hyeji	3 V	F		
		JEON Jaeik	2	M		
		SONG Yujin	1	F		
		AHN Jaesung	C	M		
5	DEN - Denmark	THUNE Tobias	4 S	M		
		LANDER Jasmin	3 V	F		
		HOLTERMANN Henrik	2	M		
		LARSEN My	1	F		
		-	C			
5	HUN - Hungary	NAGY Gyorgy	4 S	M		
		SZEKERES Ildiko	3	F		
		SZABO Gergely	2	M		
		DENCSE Blanka	1 V	F		
		WATSON Karen	C	F		
5	SCO - Scotland	CARSON Luke	4 S	M		
		BOUSIE Kirstin	3 V	F		
		TAYLOR Mark	2	M		
		McMILLAN Katie	1	F		
		RAMSAY David	C	M		
5	SUI - Switzerland	RIOS Martin	4 V	M		
		PERRET Jenny	3	F		
		WUNDERLIN Kevin	2	M		
		SIEGRIST Manuela	1 S	F		
		MARTZ Sacha	C	M		
9	ESP - Spain	VEZ Sergio	4 S	M		
		OTAEGI Oihane	3 V	F		
		UNANUE Mikel	2	M		
		OTAEGI Leire	1	F		
		-	C			

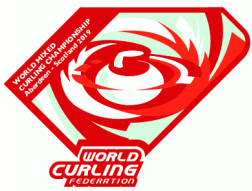

Final Standings

Rank	Team	Players	Position - Function	Gender	Group Rank	DSC
9	IRL - Ireland	WILSON John	4 S	M		
		ANDERSON Ailsa	3 V	F		
		WHYTE Craig	2	M		
		BEGLEY LUKE Niamh	1	F		
		HIBBERD David	C	M		
9	POL - Poland	DZIKOWSKI Bartosz	4 S	M		
		NOGLY Ewa	3 V	F		
		STYCH Konrad	2	M		
		RYBICKA Zuzanna	1	F		
		-	C			
9	RUS - Russia	EREMIN Alexander	4 S	M		
		MOSKALEVA Anastasia	3 V	F		
		GORYACHEV Daniil	2	M		
		MOROZOVA Daria	1	F		
		GUDIN Vasily	C	M		
9	SVK - Slovakia	MATULOVA Daniela	4 V	F		
		GALLO Juraj	3 S	M		
		MAKOVNIKOVA Slavka	2	F		
		PITONAK Tomas	1	M		
		-	C			
9	SWE - Sweden	OLOFSSON Simon	4 S	M		
		AAHLSTROEM Vilma	3 V	F		
		SJOEBERG Axel	2	M		
		STENLUND Linda	1	F		
		MABERGS Mathias	C	M		
9	TUR - Turkey	YILDIZ Dilsat	4 S	F		
		KARAGOZ Ugurcan	3 V	M		
		POLAT Oznur	2	F		
		KARATAS Alican	1	M		
		ZUMMACK Tony	C	M		
9	USA - United States	CLAWSON Hunter	4 S	M		
		GOURIANOVA Katherine	3 V	F		
		CLAWSON Eli	2	M		
		MULLANEY Sydney	1	F		
		CLAWSON Eric	C	M		
17	BLR - Belarus	PAULIUCHYK Alina	4 S	F	A4	52.03 cm
		BARKAN Dmitriy	3 V	M		
		DZIASHUK Marhartya	2	F		
		BURMISTRAU Vitali	1	M		
		ORLOV Aleksandr	C	M		
18	CZE - Czech Republic	MIKLIK Dalibor	4 V	M	B4	63.50 cm
		MIKLIKOVA Eva	3 S	F		
		MOKRIS Samuel	2	M		
		MOKRISOVA Martina	1	F		
		-	C			

Final Standings

Rank	Team	Players	Position - Function	Gender	Group Rank	DSC
19	ITA - Italy	SOLA Fabio	4 V	M	D4	70.13 cm
		PIMPINI Denise	3 S	F		
		GENRE Julien Michele	2	M		
		ALIBERTI Sara	1	F		
		-	C			
20	FIN - Finland	SIPILA Markus	4 S	M	E4	87.28 cm
		IMMONEN Lotta	3	F		
		OUNI Leo	2	M		
		SUURIPAA Tiina	1 V	F		
		KUOSMANEN Paavo	C	M		
21	KAZ - Kazakhstan	ALLIYAROVA Sitora	4 V	F	C5	46.28 cm
		ZHUZBAY Abylaikhan	3 S	M		
		-	2			
		EBAUYER Angelina	1	F		
		-	C	F		
22	ENG - England	BRAND Stuart	4 V	M	E5	49.97 cm
		SPAIN Fiona	3 S	F		
		HAVERCROFT Jonathan	2	M		
		SPAIN Kathryn	1	F		
		PAUL Elizabeth	C	F		
23	HKG - Hong Kong	CHANG Jason	4 S	M	A5	59.24 cm
		HUNG Ling-Yue	3 V	F		
		YAN Martin	2	M		
		WONG Ashura	1	F		
		COLLINS Rick	C	M		
24	JPN - Japan	MAEDA Takumi	4 S	M	D5	70.29 cm
		TABATA Momoha	3 V	F		
		NAKAHARA Asei	2	M		
		KOBAYASHI Mina	1	F		
		OGASAWARA Ayumi	C	F		
25	WAL - Wales	MEIKLE Adrian	4 S	M	B5	85.10 cm
		WATSON Dawn	3 V	F		
		TANNER Andrew	2	M		
		BEEVER Laura	1	F		
		-	C			
26	AUS - Australia	MILLIKIN Hugh	4 S	M	C6	48.31 cm
		FORGE Kim	3 V	F		
		JOHNS Steve	2	M		
		POWELL Anne	1	F		
		-	C			
27	SLO - Slovenia	TISLER Tomas	4 S	M	D6	82.85 cm
		PIPAN Nadja	3	F		
		LAJOVEC Jost	2	M		
		GORISEK Marusa	1 V	F		
		GORISEK Mitja	C	M		

Final Standings

Rank	Team	Players	Position - Function	Gender	Group Rank	DSC
28	NZL - New Zealand	DUNCAN Mhairi-Bronte	4	F	B6	95.66 cm
		FREW Benjamin	3	M		
		JEYARANJAN Thivya	2 S	F		
		FORD Kieran	1 V	M		
		-	C			
29	EST - Estonia	LILL Erkki	4 S	M	A6	108.77 cm
		MADISSON Triin	3 V	F		
		VLASSOV Mihhail	2	M		
		ELMIK Kaidi	1	F		
		-	C			
30	FRA - France	VERGNAUD Stephane	4 S	M	E6	119.87 cm
		LAFAGE Eva	3	F		
		VERGNAUD Laurent	2	M		
		LAGREE Celine	1 V	F		
		-	C			
31	LAT - Latvia	RUDZITIS Janis	4 V	M	C7	66.73 cm
		RUDZITE Jelena	3 S	F		
		PETERSONS Didzis	2	M		
		SPILNERE-PUCINA Dace	1	F		
		PETERSONE Anita	C	F		
32	AUT - Austria	UNTERBERGER Andreas	4 S	M	E7	84.58 cm
		WITSCHEN Jill	3 V	F		
		HIGATZBERGER Gernot	2	M		
		HOESS Johanna	1	F		
		SCHROEDER Bjoern	C	M		
33	TPE - Chinese Taipei	SHEN Randolph	4 S	M	D7	96.72 cm
		YANG Ko	3 V	F		
		HSU Ken	2	M		
		LEE Stephanie	1	F		
		-	C			
34	KOS - Kosovo	ANDERSEN Peter	4 S	M	A7	131.82 cm
		DAKAJ Eldena	3 V	F		
		SHABAJ Eric	2	M		
		SHATRI Mirjeta	1	F		
		ZENELI Meriton	C	M		
35	CRO - Croatia	SKENDROVIC Alberto	4 S	M	B7	152.87 cm
		MUHEK Zrinka	3 V	F		
		DZEPINA Davor	2	M		
		SIMUNJAK Marija	1	F		
		-	C			
36	BRA - Brazil	VILELA Sergio Mitsuo	4 S	M	C8	91.99 cm
		BARROS Alessandra	3 V	F		
		RODRIGUES Marcio	2	M		
		YANG Samanta	1	F		
		SARTI Bruno	C	M		

Final Standings

Rank	Team	Players	Position - Function	Gender	Group Rank	DSC
37	LUX - Luxembourg	BENOY Alex	4 S	M	D8	113.44 cm
		WAUTERS Karen	3 V	F		
		HUSI Marc	2	M		
		BENOY Susi	1	F		
		-	C			
38	NGR - Nigeria	COLE Tijani	4 S	M	A8	116.77 cm
		COLE Susana	3 V	F		
		WOODS III Harold	2	M		
		COLE-STREHLOW Carolay	1	F		
		GUMLEY Vicky	C	F		
39	AND - Andorra	GARCIA Josep	4 S	M	B8	133.73 cm
		ARCE Ana	3 V	F		
		ORTIZ Valentin	2	M		
		FOWLER Lisa Anne	1	F		
		-	C			
40	BEL - Belgium	HEYLEN Dirk	4 V	M	E8	145.71 cm
		BERUS Danielle	3	F		
		VANDERMEEREN Stephane	2	M		
		GEERINCKX Veerle	1 S	F		
		-	C			

Note:

Position and function for each team member:

4 = Fourth, **3** = Third, **2** = Second, **1** = Lead, **S** = Skip, **V** = Vice-Skip, **C** = Coach

Legend:

F Female

M Male



Competition Summary

Session	Date Time	Sheet A	Sheet B	Sheet C	Sheet D	Sheet E	Sheet F	
Session 1	12 OCT 8:00	BRA 2-14	HUN BLR 6-4	HKG CAN 6-3	GER EST 16-1	NGR SVK W-L	KOS LAT 5-12	KAZ
Session 2	12 OCT 12:00	IRL 8-5	SLO ITA 2-7	SCO LUX 3-11	JPN BEL 5-12	FIN FRA 5-6 ^{EE}	KOR ENG 7-4	AUT
Session 3	12 OCT 16:00	USA 4-7	ESP NZL 4-8	CZE DEN 3-6	NOR AND 3-6	CRO WAL 2-5	POL AUS 5-8	SWE
Session 4	12 OCT 20:30	KOR 7-6 ^{EE}	FIN SUI 3-6	RUS ENG 5-4	FRA IRL 7-6	ITA TPE 9-7 ^{EE}	TUR SCO 5-4	JPN
Session 5	13 OCT 8:00	POL 5-8	DEN CRO 6-8	WAL USA 12-2	BRA NOR 10-5	NZL SWE 3-5	ESP CZE 11-1	AND
Session 6	13 OCT 12:00	KOS 9-3	NGR HUN 9-4	KAZ LAT 5-7	AUS SVK 3-10	GER HKG 6-4	EST CAN 5-2	BLR
Session 7	13 OCT 16:00	SCO 12-3	LUX SLO 5-6	TUR IRL 6-4	TPE FIN 10-4	FRA AUT 2-11	RUS KOR 12-3	BEL
Session 8	13 OCT 20:00	AND 2-9	NZL CZE 9-4	NOR JPN 4-7	ITA ENG 1-7	SUI POL 15-1	CRO DEN 14-1	WAL
Session 9	14 OCT 8:00	AUS 6-7	KAZ AUT 5-4	BEL HUN 9-3	SWE USA 7-3	LAT SLO 11-2	LUX	
Session 10	14 OCT 12:00	ITA 10-2	TPE JPN 3-9	IRL RUS 10-2	KOR TUR 3-5	SCO FIN 8-3	ENG FRA 2-6	SUI
Session 11	14 OCT 16:00	BLR 0-8	GER DEN 6-1	AND SVK 4-7	CAN NGR 0-12	HKG BRA 2-10	KAZ EST 18-1	KOS
Session 12	14 OCT 20:00	HUN 4-7	USA AUS 2-7	ESP NOR 16-0	CRO POL 6-3	CZE NZL 4-5 ^{EE}	WAL SWE 9-2	LAT
Session 13	15 OCT 8:00	ENG 3-9	RUS		KOR 3-5	SUI SCO 11-4	TPE IRL 3-5	TUR
Session 14	15 OCT 12:00	CRO 2-12	CZE USA 8-3	SWE NZL 3-6	DEN WAL 7-5	AND LAT 3-7	HUN NOR 6-4	POL
Session 15	15 OCT 16:00	TPE 1-10	JPN FRA 7-4	AUT TUR 10-3	LUX RUS 10-3	BEL ITA 7-5	SLO SUI 9-5	FIN
Session 16	15 OCT 20:00	HKG 6-8	CAN EST 6-8	BLR KAZ 4-7	ESP BRA 1-10	AUS KOS 1-14	GER NGR 0-14	SVK
Session 17	16 OCT 8:00	FRA 10-2	BEL POL 12-1	NZL CZE 8-3	WAL CRO 3-12	DEN NOR 15-0	AND ITA 14-1	LUX
Session 18	16 OCT 12:00	SUI 7-2	AUT HKG 5-6	SVK GER 6-4	EST BLR 11-1	KOS CAN 15-1	NGR TPE 3-6	SLO
Session 19	16 OCT 16:00	ESP 9-3	LAT RUS 7-5	FIN BEL 1-13	ENG LUX 2-10	IRL TUR 2-5	JPN HUN 6-5	AUS
Session 20	16 OCT 20:00	SWE 10-2	BRA GER 21-1	NGR SLO 6-8	SCO AUT 2-9	KOR BLR 4-5	SVK KAZ 6-7	USA
Session 21	17 OCT 8:00		LUX 2-5	TPE HKG 6-2	KOS CAN 7-2	EST BEL 3-6	SUI NZL 7-6	CRO
Session 22	17 OCT 12:00	WAL 1-9	NOR KOR 7-2	ENG AND 1-7	POL JPN 11-5	SLO DEN 6-1	CZE ESP 7-2	BRA
Session 23	17 OCT 16:00	EST 1-7	SVK KOS 3-17	CAN NGR 1-19	BLR KAZ 5-7	SWE AUS 7-5	USA GER 6-7	HKG
Session 24	17 OCT 20:00	TUR 8-5 ^{EE}	ITA BRA 3-11	LAT FIN 8-0	AUT ESP 7-5	HUN SCO 7-3	IRL RUS 9-2	FRA
1/8-Finals 1	18 OCT 9:00		DEN 8-3	IRL SVK 1-9	NOR ESP 2-6	HUN CAN 9-4	SWE	
1/8-Finals 2	18 OCT 13:00		USA 2-7	SUI GER 5-3	POL RUS 1-9	KOR SCO 6-3	TUR	
Quarter-finals	18 OCT 19:00		GER 9-7	SCO SUI 3-6	KOR CAN 6-4	DEN NOR 9-6	HUN	
Semi-finals	19 OCT 9:00			CAN 6-5	NOR	KOR 4-6	GER	
Finals	19 OCT 15:00		KOR 5-6	NOR		CAN 6-5	GER	

Competition Summary

Standings after Round Robin

Group-A

Rank	Team	Games	Wins	Losses				
1	CAN - Canada	7	7	0	Q	DSC	31.72cm	
2	GER - Germany	7	5	2	Q w1	DSC	37.42cm	
3	SVK - Slovakia	7	5	2	Q w0	DSC	59.37cm	
4	BLR - Belarus	7	4	3	w1	DSC	52.03cm	
5	HKG - Hong Kong	7	4	3	w0			
6	EST - Estonia	7	2	5				
7	KOS - Kosovo	7	1	6				
8	NGR - Nigeria	7	0	7				

Group-B

Rank	Team	Games	Wins	Losses				
1	NOR - Norway	7	6	1	Q w1	DSC	68.56cm	
2	DEN - Denmark	7	6	1	Q w0	DSC	70.81cm	
3	POL - Poland	7	5	2	Q w1	DSC	55.05cm	
4	CZE - Czech Republic	7	5	2	w0	DSC	63.50cm	
5	WAL - Wales	7	3	4				
6	NZL - New Zealand	7	2	5				
7	CRO - Croatia	7	1	6				
8	AND - Andorra	7	0	7				

Group-C

Rank	Team	Games	Wins	Losses				
1	ESP - Spain	7	7	0	Q	DSC	72.28cm	
2	USA - United States	7	5	2	Q w1	DSC	84.72cm	
3	HUN - Hungary	7	5	2	Q w0	DSC	55.87cm	
4	SWE - Sweden	7	4	3	Q	DSC	40.72cm	
5	KAZ - Kazakhstan	7	3	4	w1			
6	AUS - Australia	7	3	4	w0			
7	LAT - Latvia	7	1	6				
8	BRA - Brazil	7	0	7				

Group-D

Rank	Team	Games	Wins	Losses				
1	SCO - Scotland	7	7	0	Q	DSC	48.13cm	
2	IRL - Ireland	7	5	2	Q	DSC	79.85cm	
3	TUR - Turkey	7	4	3	Q w1	DSC	69.22cm	
4	ITA - Italy	7	4	3	w1	DSC	70.13cm	
5	JPN - Japan	7	4	3	w1	DSC	70.29cm	
6	SLO - Slovenia	7	2	5	w1			
7	TPE - Chinese Taipei	7	2	5	w0			
8	LUX - Luxembourg	7	0	7				

Group-E

Rank	Team	Games	Wins	Losses				
1	RUS - Russia	7	7	0	Q	DSC	43.10cm	
2	SUI - Switzerland	7	6	1	Q	DSC	43.48cm	
3	KOR - Korea	7	5	2	Q	DSC	71.57cm	
4	FIN - Finland	7	4	3		DSC	87.28cm	
5	ENG - England	7	3	4				
6	FRA - France	7	2	5				
7	AUT - Austria	7	1	6				
8	BEL - Belgium	7	0	7				

Merged Group Standings

Rank	Team	Round Robin Results			Rank	Team	Round Robin Results			Rank	Team	Round Robin Results		
		Group	Rank	DSC			Group	Rank	DSC			Group	Rank	DSC
1	CAN - Canada	A	1	31.72cm	15	KOR - Korea	E	3	71.57cm	29	EST - Estonia	A	6	108.77cm
2	RUS - Russia	E	1	43.10cm	16	SWE - Sweden	C	4	40.72cm	30	FRA - France	E	6	119.87cm
3	SCO - Scotland	D	1	48.13cm	17	BLR - Belarus	A	4	52.03cm	31	LAT - Latvia	C	7	66.73cm
4	NOR - Norway	B	1	68.56cm	18	CZE - Czech Republic	B	4	63.50cm	32	AUT - Austria	E	7	84.58cm
5	ESP - Spain	C	1	72.28cm	19	ITA - Italy	D	4	70.13cm	33	TPE - Chinese Taipei	D	7	96.72cm
6	GER - Germany	A	2	37.42cm	20	FIN - Finland	E	4	87.28cm	34	KOS - Kosovo	A	7	131.82cm
7	SUI - Switzerland	E	2	43.48cm	21	KAZ - Kazakhstan	C	5	46.28cm	35	CRO - Croatia	B	7	152.87cm
8	DEN - Denmark	B	2	70.81cm	22	ENG - England	E	5	49.97cm	36	BRA - Brazil	C	8	91.99cm
9	IRL - Ireland	D	2	79.85cm	23	HKG - Hong Kong	A	5	59.24cm	37	LUX - Luxembourg	D	8	113.44cm
10	USA - United States	C	2	84.72cm	24	JPN - Japan	D	5	70.29cm	38	NGR - Nigeria	A	8	116.77cm
11	POL - Poland	B	3	55.05cm	25	WAL - Wales	B	5	85.10cm	39	AND - Andorra	B	8	133.73cm
12	HUN - Hungary	C	3	55.87cm	26	AUS - Australia	C	6	48.31cm	40	BEL - Belgium	E	8	145.71cm
13	SVK - Slovakia	A	3	59.37cm	27	SLO - Slovenia	D	6	82.85cm					
14	TUR - Turkey	D	3	69.22cm	28	NZL - New Zealand	B	6	95.66cm					



Competition Summary

Play-offs Bracket

1/8 finals		Quarter-finals		Semi-finals		Finals		Final Standings	
1	CAN 9							1	CAN - Canada
	Sheet E G1	CAN 6						2	GER - Germany
16	SWE 4							3	NOR - Norway
	Sheet D G9							4	KOR - Korea
8	DEN 8							5	DEN - Denmark
	Sheet B G2	DEN 4						5	HUN - Hungary
9	IRL 3							5	SCO - Scotland
	Sheet C G13							5	SUI - Switzerland
5	ESP 2							9	ESP - Spain
	Sheet D G3	HUN 6						9	IRL - Ireland
12	HUN 6							9	POL - Poland
	Sheet E G10	NOR 5						9	RUS - Russia
4	NOR 9							9	SVK - Slovakia
	Sheet C G4	NOR 9						9	SWE - Sweden
13	SVK 1							9	TUR - Turkey
	Sheet D G15							9	USA - United States
3	SCO 6							17	BLR - Belarus
	Sheet E G5	SCO 7						18	CZE - Czech Republic
14	TUR 3							19	ITA - Italy
	Sheet B G11	GER 6						20	FIN - Finland
6	GER 5							21	KAZ - Kazakhstan
	Sheet C G6	GER 9						22	ENG - England
11	POL 3							23	HKG - Hong Kong
	Sheet E G14							24	JPN - Japan
7	SUI 7							25	WAL - Wales
	Sheet B G7	SUI 3						26	AUS - Australia
10	USA 2							27	SLO - Slovenia
	Sheet C G12	KOR 4						28	NZL - New Zealand
2	RUS 1							29	EST - Estonia
	Sheet D G8	KOR 6						30	FRA - France
15	KOR 9							31	LAT - Latvia
	Sheet B G16							32	AUT - Austria
		NOR 6						33	TPE - Chinese Taipei
								34	KOS - Kosovo
		KOR 5						35	CRO - Croatia
								36	BRA - Brazil
								37	LUX - Luxembourg
								38	NGR - Nigeria
								39	AND - Andorra
								40	BEL - Belgium

Legend:	DSC Draw Shot Challenge	EE Extra End	L Loss
Q Qualified for the play-offs	W Win	wn Number of wins (n) against tied teams	



SAT 19 OCT 2019
Start Time 15:00

Finals

Session Results and Standings

Sheet	Game	Team	LSFE	1	2	3	4	5	6	7	8	Extra Ends	Total
B	11	KOR - Korea	*	0	2	0	2	0	0	1	0		5
	11	NOR - Norway		0	0	1	0	2	1	0	2		6
D	11	CAN - Canada	*	0	0	1	0	3	0	0	2		6
	11	GER - Germany		0	0	0	1	0	3	1	0		5

Play-offs Bracket

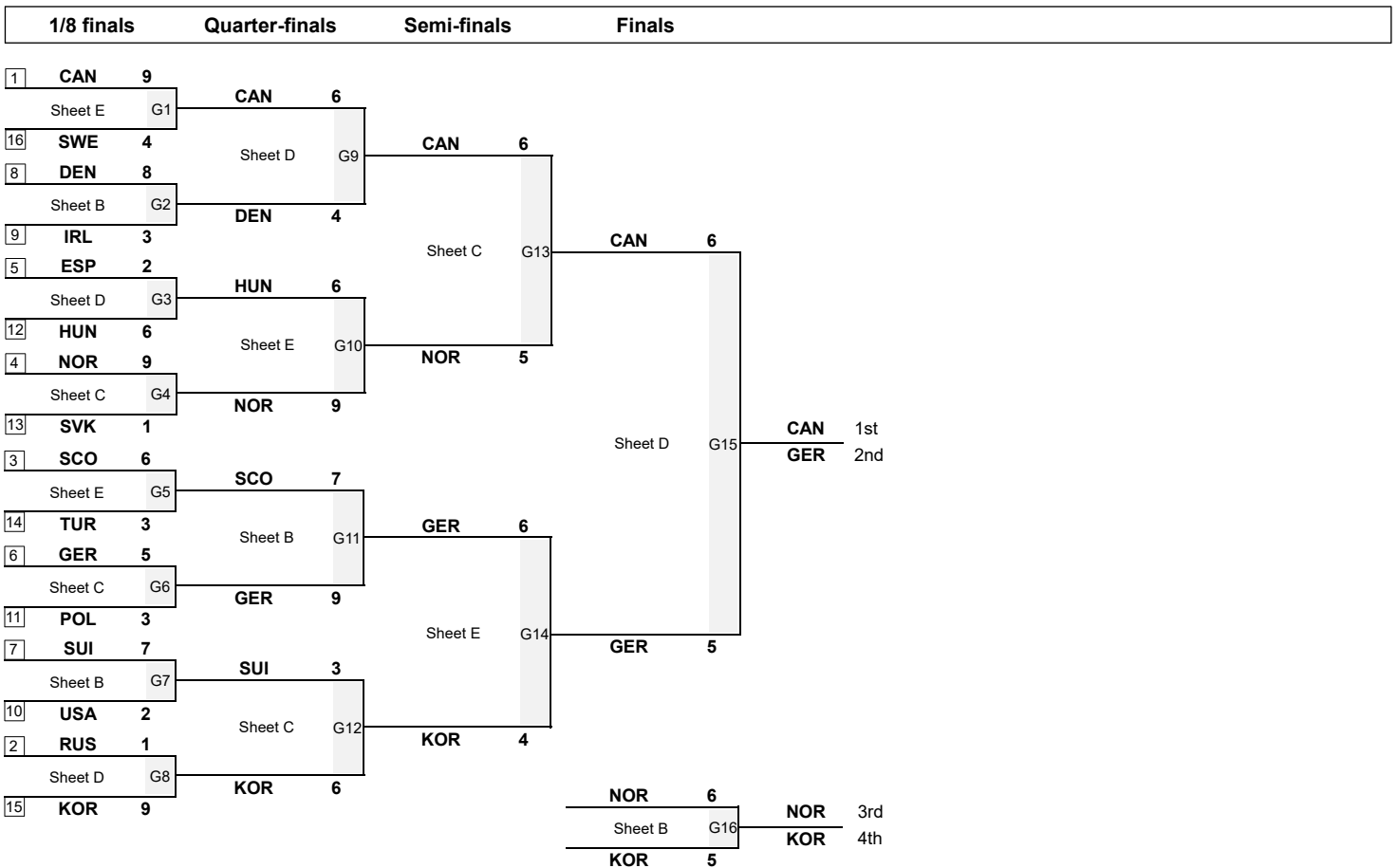

Legend:
LSFE(*) Last Stone First End



Scoring Analysis

Team	Games		LSFE	Stolen Ends	Last Stone Eff.	Force Eff.	Points Scored						Total	Plus / Minus
							0	1	2	3	4	>4		
NOR	11	For	5	28	56%	52%	1	22	18	8	2	1	95	+55
		Against	6	4			1	13	11	0	0	1	40	
CAN	11	For	7	15	66%	72%	4	15	16	5	5	2	92	+53
		Against	4	4			4	22	4	3	0	0	39	
GER	11	For	8	20	48%	48%	4	23	13	4	4	3	93	+51
		Against	3	2			5	12	9	4	0	0	42	
DEN	9	For	5	15	52%	68%	3	16	15	3	3	0	67	+38
		Against	4	3			1	16	5	1	0	0	29	
RUS	8	For	8	10	50%	75%	3	8	11	5	3	1	63	+34
		Against	0	8			0	15	4	0	0	1	29	
SCO	9	For	6	10	58%	65%	1	13	11	8	1	1	68	+31
		Against	3	7			1	19	6	2	0	0	37	
POL	8	For	5	11	52%	63%	2	14	9	4	2	1	57	+30
		Against	3	4			3	13	7	0	0	0	27	
CZE	7	For	5	10	60%	46%	1	9	11	4	1	1	52	+26
		Against	2	4			3	9	7	1	0	0	26	
HUN	9	For	6	16	46%	55%	1	21	10	4	2	1	66	+24
		Against	3	6			0	15	7	3	1	0	42	
SUI	9	For	6	16	55%	53%	7	21	11	2	1	0	53	+23
		Against	3	1			5	10	5	2	1	0	30	
ESP	8	For	3	12	39%	67%	0	11	9	6	1	0	51	+22
		Against	5	8			6	17	6	0	0	0	29	
KOR	11	For	5	11	47%	52%	5	18	10	6	2	1	70	+21
		Against	6	6			7	17	11	2	1	0	49	
BLR	7	For	5	14	17%	67%	2	12	7	3	1	2	50	+20
		Against	2	13			2	16	5	0	1	0	30	
FIN	7	For	3	13	55%	36%	2	13	6	8	0	1	54	+19
		Against	4	5			1	9	7	0	3	0	35	
ITA	7	For	5	10	30%	56%	2	14	7	3	1	2	51	+17
		Against	2	6			1	13	6	3	0	0	34	
JPN	7	For	5	8	47%	50%	5	13	6	1	2	2	48	+16
		Against	2	3			0	9	8	1	1	0	32	
EST	7	For	1	14	13%	50%	3	14	4	2	4	1	51	+15
		Against	6	12			0	12	8	0	2	0	36	
HKG	7	For	5	12	38%	60%	1	17	5	5	1	0	46	+14
		Against	2	8			1	15	7	1	0	0	32	
USA	8	For	1	10	50%	55%	2	10	14	2	2	0	52	+13
		Against	7	6			1	16	7	3	0	0	39	

Scoring Analysis

Team	Games		LSFE	Stolen Ends	Last Stone Eff.	Force Eff.	Points Scored						Total	Plus / Minus
							0	1	2	3	4	>4		
IRL	8	For	4	9	34%	74%	0	15	8	2	3	0	49	+9
		Against	4	10			2	21	6	1	1	0	40	
KAZ	7	For	4	8	43%	39%	1	10	9	4	2	0	48	+5
		Against	3	6			1	10	10	3	1	0	43	
SVK	8	For	3	13	35%	33%	3	11	11	1	1	0	40	+4
		Against	4	6			3	7	6	4	0	1	36	
AUS	7	For	6	9	27%	43%	2	15	7	3	1	0	42	+3
		Against	1	9			2	13	6	2	2	0	39	
TUR	8	For	3	8	23%	56%	3	16	7	3	0	1	44	+3
		Against	5	11			4	18	10	1	0	0	41	
SWE	8	For	6	7	37%	42%	3	15	10	1	1	1	47	+2
		Against	2	6			0	11	11	0	3	0	45	
SLO	7	For	3	8	35%	42%	0	16	8	1	2	0	43	-2
		Against	4	4			1	10	7	3	3	0	45	
ENG	7	For	3	8	17%	60%	0	10	7	2	1	0	34	-6
		Against	4	12			1	17	7	3	0	0	40	
FRA	7	For	3	7	18%	50%	1	16	5	0	2	0	34	-8
		Against	4	6			2	12	8	3	0	1	42	
NZL	7	For	3	6	19%	33%	3	9	6	1	1	1	33	-16
		Against	4	14			0	15	8	6	0	0	49	
LAT	7	For	4	4	30%	40%	2	10	5	1	1	1	32	-22
		Against	3	13			1	12	7	8	1	0	54	
TPE	7	For	3	10	12%	62%	0	16	3	2	0	0	28	-24
		Against	4	15			1	17	4	4	1	2	52	
WAL	7	For	2	5	22%	29%	1	13	5	0	1	0	27	-24
		Against	5	9			4	9	12	3	1	1	51	
AUT	7	For	4	4	3%	50%	0	14	1	1	0	0	19	-34
		Against	3	17			1	14	7	7	1	0	53	
BEL	7	For	0	1	22%	39%	0	7	7	0	0	0	21	-47
		Against	7	14			1	13	8	7	3	1	68	
AND	7	For	3	2	6%	36%	0	9	2	0	0	0	13	-48
		Against	4	22			0	17	9	3	3	1	61	
CRO	7	For	0	5	15%	33%	0	9	5	0	0	1	24	-49
		Against	7	16			0	10	10	3	6	2	73	
KOS	7	For	2	5	13%	10%	0	9	4	0	0	0	17	-52
		Against	4	15			1	6	6	6	4	3	69	
LUX	7	For	1	2	8%	24%	0	12	2	0	0	0	16	-57
		Against	6	13			1	11	7	5	3	4	73	



Scoring Analysis

Team	Games		LSFE	Stolen Ends	Last Stone Eff.	Force Eff.	Points Scored						Total	Plus / Minus
							0	1	2	3	4	>4		
BRA	7	For	1	1	7%	20%	0	10	2	0	0	0	14	-60
		Against	6	16			0	6	16	3	3	3	74	
NGR	7	For	3	0	3%	0%	0	4	0	1	0	0	7	-99
		Against	4	33			0	13	12	5	8	4	106	
Total	156			377			68	530	307	106	54	25	1811	

Note:

Stolen ends are the ends won without the last stone advantage.

Last Stone Efficiency: Scoring two or more points with last stone advantage.

Force Efficiency: Forcing the opponent team to score only one point when they have the last stone advantage.

Legend:

>4 More than four points scored

Eff. Efficiency

LSFE Last Stone First End

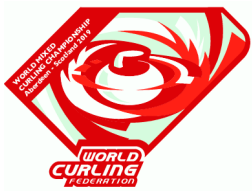

Summary of Big Ends

Points Scored	By	Against	Session	End	Game Result
7	EST - Estonia	KOS - Kosovo	11	5	18 : 1
6	BLR - Belarus	NGR - Nigeria	23	7	19 : 1
6	GER - Germany	NGR - Nigeria	20	4	21 : 1
6	JPN - Japan	LUX - Luxembourg	2	6	11 : 3
6	JPN - Japan	TPE - Chinese Taipei	15	1	10 : 1
6	KOR - Korea	RUS - Russia	8F	3	9 : 1
6	RUS - Russia	BEL - Belgium	15	6	10 : 3
5	BLR - Belarus	NGR - Nigeria	23	2	19 : 1
5	CAN - Canada	KOS - Kosovo	23	1	17 : 3
5	CAN - Canada	KOS - Kosovo	23	3	17 : 3
5	CRO - Croatia	WAL - Wales	5	5	6 : 8
5	CZE - Czech Republic	CRO - Croatia	14	1	12 : 2
5	FIN - Finland	FRA - France	7	6	10 : 4
5	GER - Germany	SVK - Slovakia	6	4	10 : 3
5	GER - Germany	NGR - Nigeria	20	1	21 : 1
5	HUN - Hungary	BRA - Brazil	1	3	14 : 2
5	ITA - Italy	TPE - Chinese Taipei	10	7	10 : 2
5	ITA - Italy	LUX - Luxembourg	17	1	14 : 1
5	LAT - Latvia	BRA - Brazil	24	3	11 : 3
5	NOR - Norway	AND - Andorra	17	6	15 : 0
5	NZL - New Zealand	NOR - Norway	5	4	5 : 10
5	POL - Poland	CRO - Croatia	8	3	15 : 1
5	SCO - Scotland	LUX - Luxembourg	7	1	12 : 3
5	SWE - Sweden	BRA - Brazil	20	6	10 : 2
5	TUR - Turkey	LUX - Luxembourg	15	4	10 : 3
4	AUS - Australia	HUN - Hungary	19	1	5 : 6
4	BLR - Belarus	EST - Estonia	16	4	8 : 6
4	CAN - Canada	NGR - Nigeria	18	1	15 : 1
4	CAN - Canada	NGR - Nigeria	18	5	15 : 1
4	CAN - Canada	EST - Estonia	21	5	7 : 2
4	CAN - Canada	KOS - Kosovo	23	6	17 : 3
4	CAN - Canada	SWE - Sweden	8F	2	9 : 4
4	CZE - Czech Republic	AND - Andorra	5	5	11 : 1
4	DEN - Denmark	WAL - Wales	8	5	14 : 1
4	DEN - Denmark	CRO - Croatia	17	1	12 : 3
4	DEN - Denmark	CRO - Croatia	17	6	12 : 3
4	ENG - England	BEL - Belgium	19	3	13 : 1
4	ESP - Spain	KAZ - Kazakhstan	16	5	7 : 4



Summary of Big Ends

Points Scored	By	Against	Session	End	Game Result
4	EST - Estonia	NGR - Nigeria	1	1	16 : 1
4	EST - Estonia	NGR - Nigeria	1	7	16 : 1
4	EST - Estonia	KOS - Kosovo	11	1	18 : 1
4	EST - Estonia	BLR - Belarus	16	1	6 : 8
4	FRA - France	FIN - Finland	7	4	4 : 10
4	FRA - France	BEL - Belgium	17	4	10 : 2
4	GER - Germany	KOS - Kosovo	16	1	14 : 1
4	GER - Germany	KOS - Kosovo	16	4	14 : 1
4	GER - Germany	NGR - Nigeria	20	3	21 : 1
4	GER - Germany	NGR - Nigeria	20	6	21 : 1
4	HKG - Hong Kong	NGR - Nigeria	11	1	12 : 0
4	HUN - Hungary	BRA - Brazil	1	1	14 : 2
4	HUN - Hungary	SWE - Sweden	9	4	9 : 3
4	IRL - Ireland	SLO - Slovenia	2	5	8 : 5
4	IRL - Ireland	JPN - Japan	10	5	9 : 3
4	IRL - Ireland	LUX - Luxembourg	19	4	10 : 2
4	ITA - Italy	IRL - Ireland	4	5	6 : 7
4	JPN - Japan	SLO - Slovenia	22	1	11 : 5
4	JPN - Japan	SLO - Slovenia	22	3	11 : 5
4	KAZ - Kazakhstan	LAT - Latvia	1	6	12 : 5
4	KAZ - Kazakhstan	BRA - Brazil	11	2	10 : 2
4	KOR - Korea	BEL - Belgium	7	7	12 : 3
4	KOR - Korea	SUI - Switzerland	QF	8	6 : 3
4	LAT - Latvia	AUS - Australia	6	4	5 : 7
4	NOR - Norway	CRO - Croatia	12	2	16 : 0
4	NOR - Norway	CRO - Croatia	12	4	16 : 0
4	NZL - New Zealand	AND - Andorra	8	3	9 : 2
4	POL - Poland	CRO - Croatia	8	1	15 : 1
4	POL - Poland	CRO - Croatia	8	5	15 : 1
4	RUS - Russia	AUT - Austria	7	1	11 : 2
4	RUS - Russia	KOR - Korea	10	5	10 : 2
4	RUS - Russia	FIN - Finland	19	5	7 : 5
4	SCO - Scotland	TPE - Chinese Taipei	13	6	11 : 4
4	SLO - Slovenia	LUX - Luxembourg	9	5	11 : 2
4	SLO - Slovenia	LUX - Luxembourg	9	7	11 : 2
4	SUI - Switzerland	FIN - Finland	15	7	9 : 5
4	SVK - Slovakia	NGR - Nigeria	16	5	14 : 0
4	SWE - Sweden	AUS - Australia	3	4	8 : 5

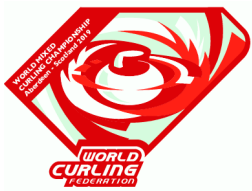

SAT 19 OCT 2019
Start Time 9:00

Semi-finals

Session Results and Standings

Sheet	Game	Team	LSFE	1	2	3	4	5	6	7	8	Extra Ends	Total
C	10	CAN - Canada	*	2	0	0	1	1	0	2	0		6
	10	NOR - Norway		0	0	1	0	0	3	0	1		5
E	10	KOR - Korea		0	0	1	0	2	0	1	0		4
	10	GER - Germany	*	0	1	0	2	0	1	0	2		6

Play-offs Bracket

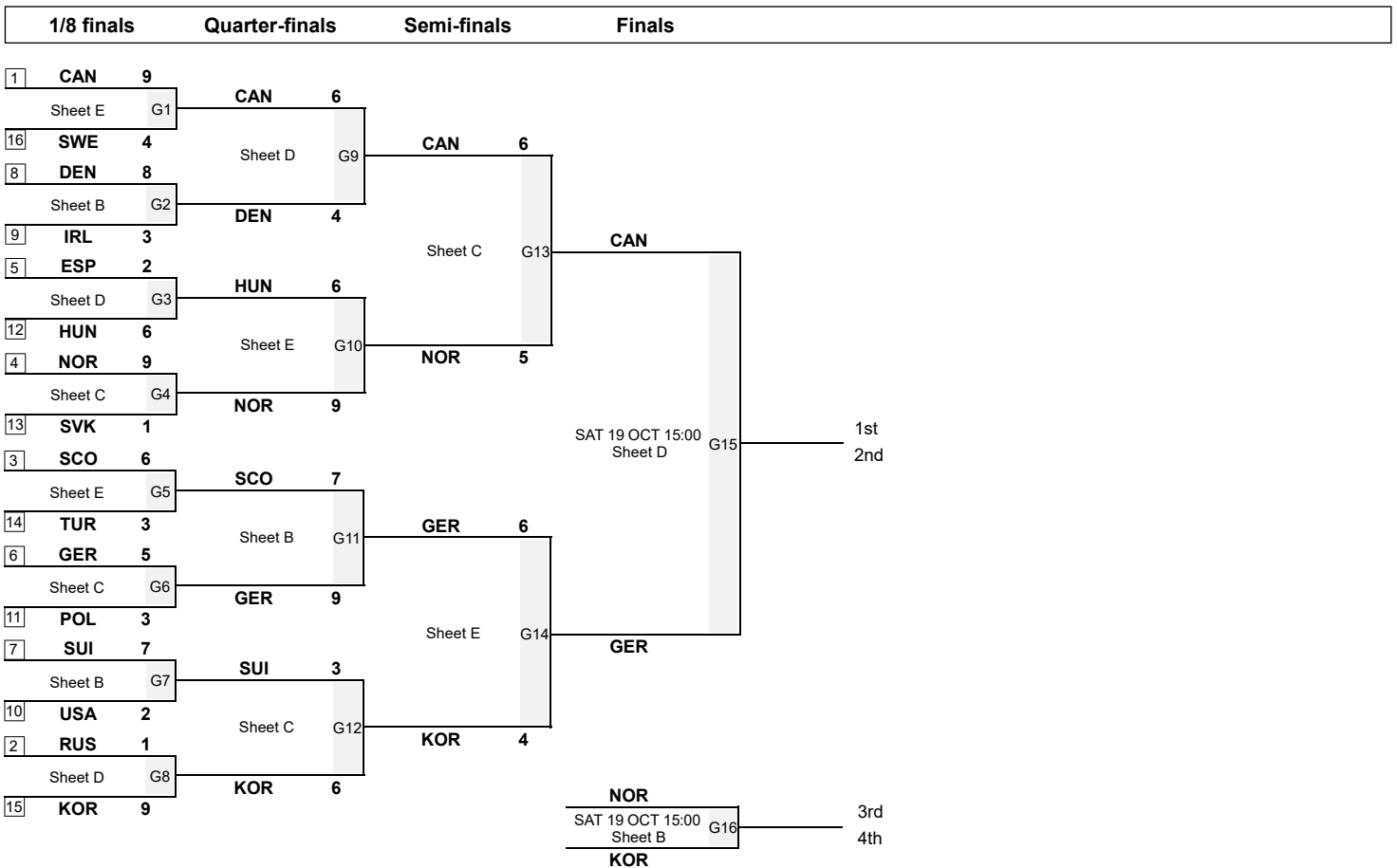

Legend:
LSFE(*) Last Stone First End



FRI 18 OCT 2019
Start Time 19:00

Quarter-finals

Session Results and Standings

Sheet	Game	Team	LSFE	1	2	3	4	5	6	7	8	Extra Ends	Total
B	9	GER - Germany	*	1	0	3	0	2	1	0	2		9
	9	SCO - Scotland		0	2	0	3	0	0	2	0		7
C	9	SUI - Switzerland	*	0	2	0	0	0	1	0	0		3
	9	KOR - Korea		0	0	2	0	0	0	0	4		6
D	9	CAN - Canada	*	2	0	1	0	0	2	0	1		6
	9	DEN - Denmark		0	1	0	1	0	0	2	0		4
E	9	NOR - Norway		0	2	2	0	0	2	0	3		9
	9	HUN - Hungary	*	1	0	0	2	1	0	2	0		6

Play-offs Bracket

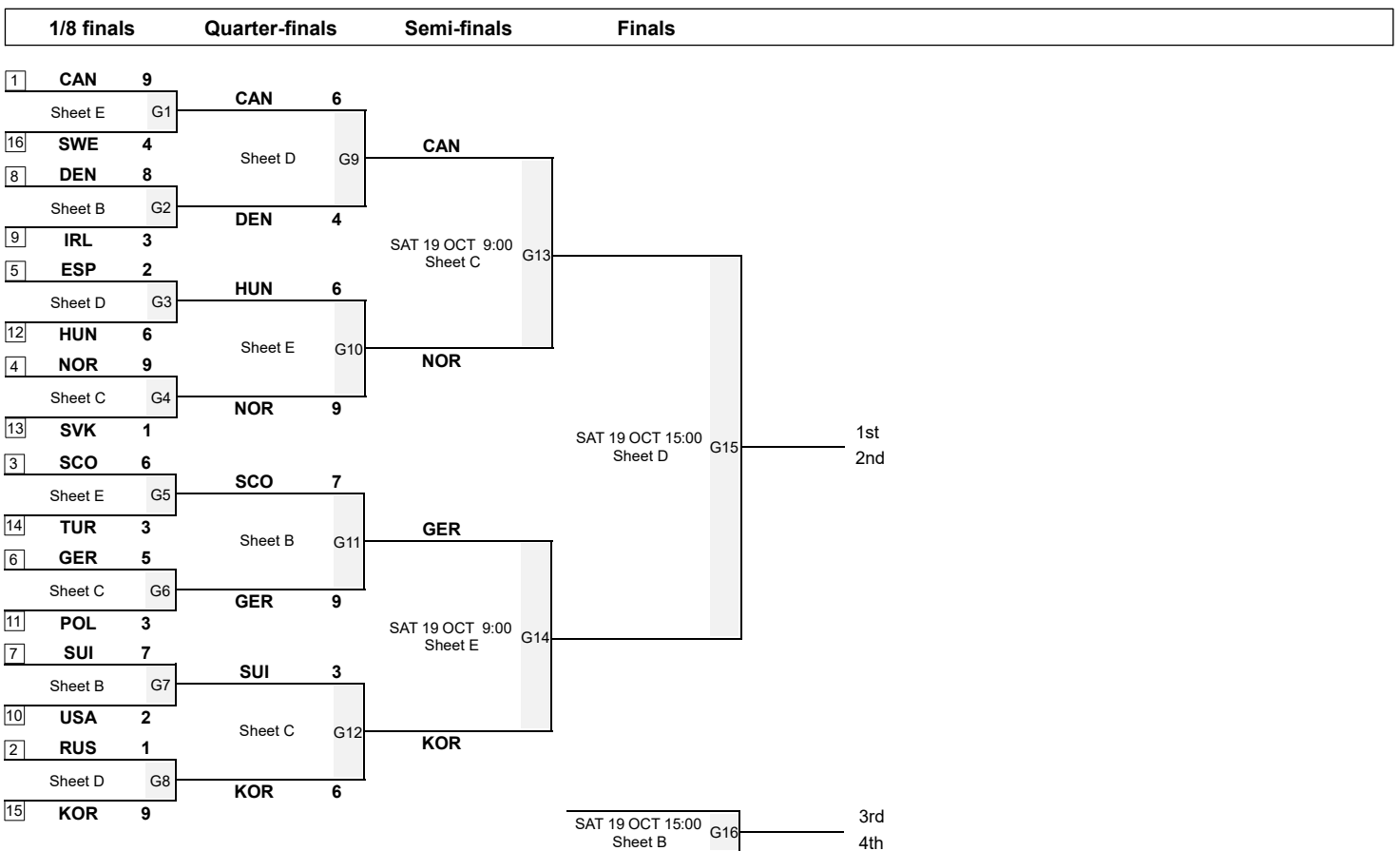

Legend:
LSFE(*) Last Stone First End



FRI 18 OCT 2019
Start Time 13:00

1/8 Finals Session 2

Session Results and Standings

Sheet	Game	Team	LSFE	1	2	3	4	5	6	7	8	Extra Ends	Total
B	8	USA - United States		0	1	0	0	1	0	0	X		2
	8	SUI - Switzerland	*	2	0	1	1	0	2	1	X		7
C	8	GER - Germany	*	1	1	0	0	1	0	0	2		5
	8	POL - Poland		0	0	0	2	0	1	0	0		3
D	8	RUS - Russia	*	0	1	0	0	0	0	X	X		1
	8	KOR - Korea		0	0	6	1	1	1	X	X		9
E	8	SCO - Scotland	*	0	2	0	2	1	1	0	X		6
	8	TUR - Turkey		1	0	1	0	0	0	1	X		3

Play-offs Bracket

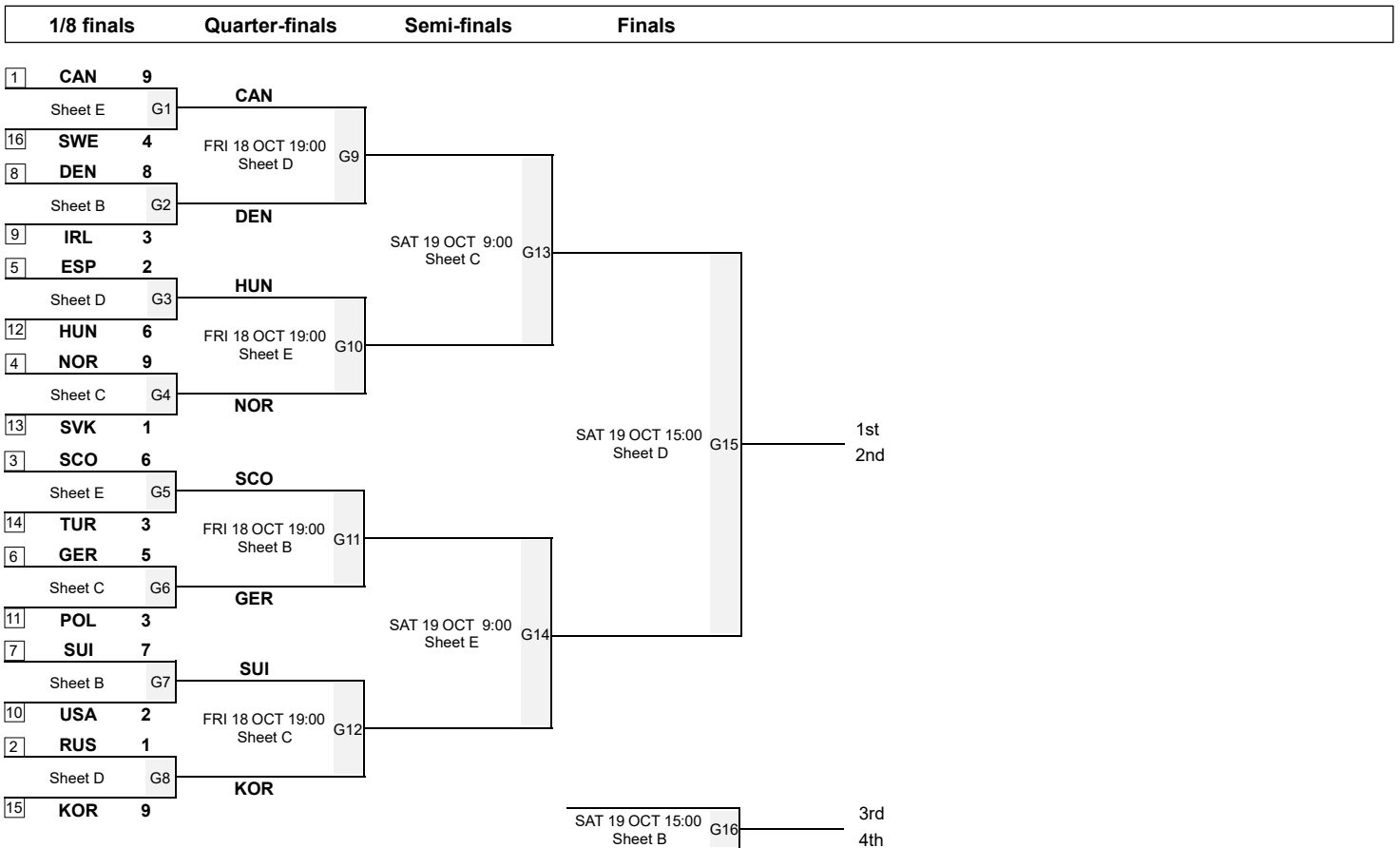

Legend:
 LSFE(*) Last Stone First End X Unplayed/unfinished end due to concession



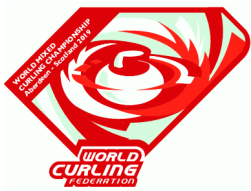

FRI 18 OCT 2019
Start Time 9:00

1/8 Finals Session 1

Session Results and Standings

Sheet	Game	Team	LSFE	1	2	3	4	5	6	7	8	Extra Ends	Total
B	8	DEN - Denmark		1	0	2	0	1	2	2	X		8
	8	IRL - Ireland	*	0	2	0	1	0	0	0	X		3
C	8	SVK - Slovakia	*	0	0	0	1	0	0	X	X		1
	8	NOR - Norway		1	2	1	0	3	2	X	X		9
D	8	ESP - Spain	*	0	1	0	0	0	0	1	X		2
	8	HUN - Hungary		1	0	1	1	2	1	0	X		6
E	8	CAN - Canada		2	4	0	1	0	0	2	X		9
	8	SWE - Sweden	*	0	0	1	0	2	1	0	X		4

Play-offs Bracket

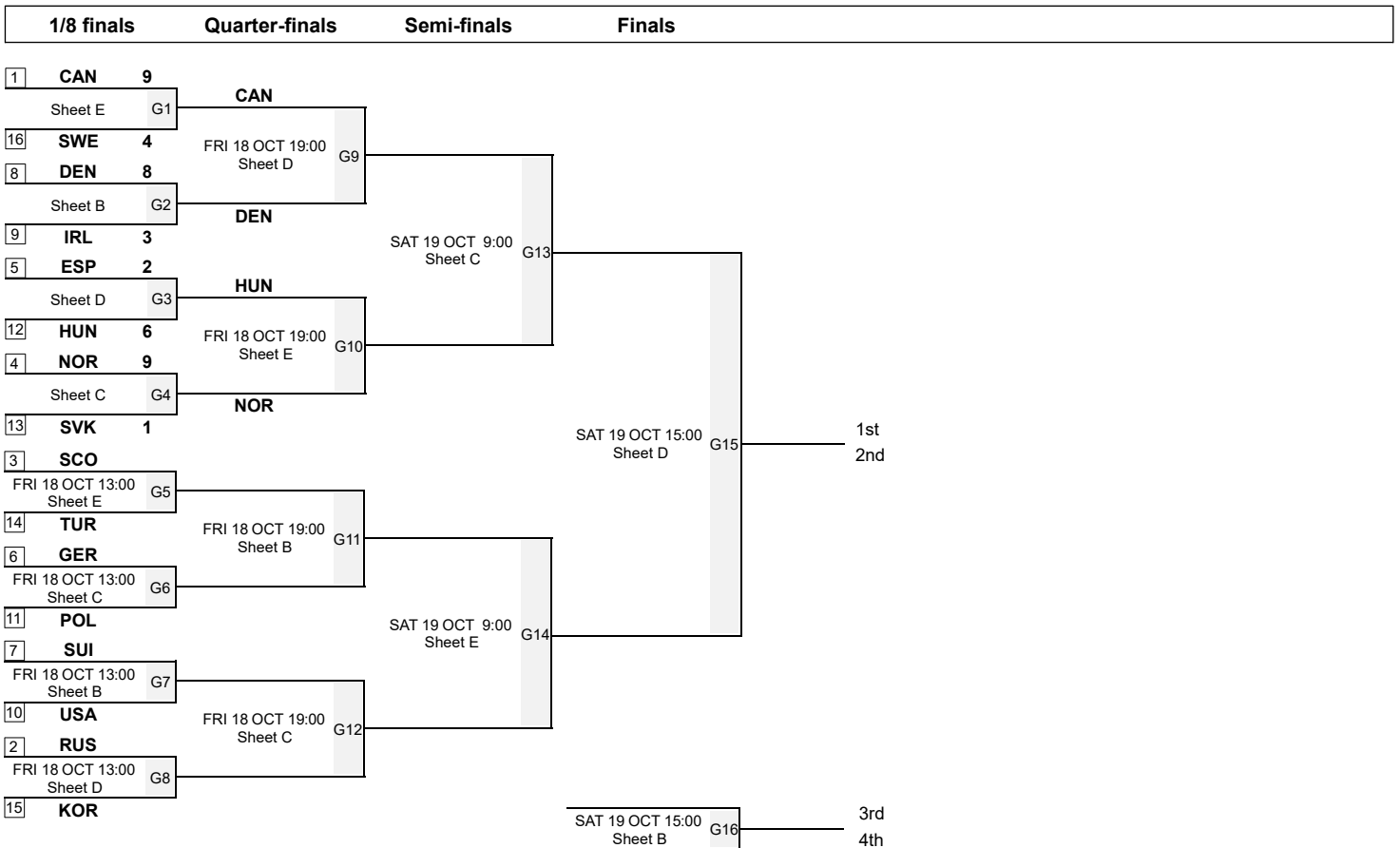

Legend:
 LSFE(*) Last Stone First End X Unplayed/unfinished end due to concession



Competition Matrix

Group A

Team	BLR	CAN	EST	GER	HKG	KOS	NGR	SVK
BLR		2 - 5	8 - 6	0 - 8	6 - 4	11 - 1	19 - 1	4 - 5
CAN	5 - 2		7 - 2	6 - 3	8 - 6	17 - 3	15 - 1	7 - 4
EST	6 - 8	2 - 7		4 - 6	4 - 6	18 - 1	16 - 1	1 - 7
GER	8 - 0	3 - 6	6 - 4		6 - 7	14 - 1	21 - 1	10 - 3
HKG	4 - 6	6 - 8	6 - 4	7 - 6		6 - 2	12 - 0	5 - 6
KOS	1 - 11	3 - 17	1 - 18	1 - 14	2 - 6		9 - 3	L - W
NGR	1 - 19	1 - 15	1 - 16	1 - 21	0 - 12	3 - 9		0 - 14
SVK	5 - 4	4 - 7	7 - 1	3 - 10	6 - 5	W - L	14 - 0	

Standings after Round Robin

Rank	Team	Games	Wins	Losses			
1	CAN - Canada	7	7	0	Q		DSC 31.72cm
2	GER - Germany	7	5	2	Q	w1	DSC 37.42cm
3	SVK - Slovakia	7	5	2	Q	w0	DSC 59.37cm
4	BLR - Belarus	7	4	3		w1	DSC 52.03cm
5	HKG - Hong Kong	7	4	3		w0	
6	EST - Estonia	7	2	5			
7	KOS - Kosovo	7	1	6			
8	NGR - Nigeria	7	0	7			

Competition Matrix

Group B

Team	AND	CRO	CZE	DEN	NOR	NZL	POL	WAL
AND		3 - 6	1 - 11	1 - 6	0 - 15	2 - 9	1 - 7	5 - 7
CRO	6 - 3		2 - 12	3 - 12	0 - 16	6 - 7	1 - 15	6 - 8
CZE	11 - 1	12 - 2		1 - 6	9 - 4	8 - 4	3 - 6	8 - 3
DEN	6 - 1	12 - 3	6 - 1		3 - 6	6 - 3	8 - 5	14 - 1
NOR	15 - 0	16 - 0	4 - 9	6 - 3		10 - 5	6 - 4	9 - 1
NZL	9 - 2	7 - 6	4 - 8	3 - 6	5 - 10		1 - 12	4 - 5
POL	7 - 1	15 - 1	6 - 3	5 - 8	4 - 6	12 - 1		5 - 2
WAL	7 - 5	8 - 6	3 - 8	1 - 14	1 - 9	5 - 4	2 - 5	

Standings after Round Robin

Rank	Team	Games	Wins	Losses				
1	NOR - Norway	7	6	1	Q	w1	DSC	68.56cm
2	DEN - Denmark	7	6	1	Q	w0	DSC	70.81cm
3	POL - Poland	7	5	2	Q	w1	DSC	55.05cm
4	CZE - Czech Republic	7	5	2		w0	DSC	63.50cm
5	WAL - Wales	7	3	4				
6	NZL - New Zealand	7	2	5				
7	CRO - Croatia	7	1	6				
8	AND - Andorra	7	0	7				

Competition Matrix

Group C

Team	AUS	BRA	ESP	HUN	KAZ	LAT	SWE	USA
AUS		10 - 1	2 - 7	5 - 6	6 - 7	7 - 5	5 - 8	7 - 5
BRA	1 - 10		2 - 7	2 - 14	2 - 10	3 - 11	2 - 10	2 - 12
ESP	7 - 2	7 - 2		7 - 5	7 - 4	9 - 3	5 - 3	7 - 4
HUN	6 - 5	14 - 2	5 - 7		9 - 4	7 - 3	9 - 3	4 - 7
KAZ	7 - 6	10 - 2	4 - 7	4 - 9		12 - 5	5 - 7	6 - 7
LAT	5 - 7	11 - 3	3 - 9	3 - 7	5 - 12		2 - 9	3 - 7
SWE	8 - 5	10 - 2	3 - 5	3 - 9	7 - 5	9 - 2		3 - 8
USA	5 - 7	12 - 2	4 - 7	7 - 4	7 - 6	7 - 3	8 - 3	

Standings after Round Robin

Rank	Team	Games	Wins	Losses			
1	ESP - Spain	7	7	0	Q		DSC 72.28cm
2	USA - United States	7	5	2	Q	w1	DSC 84.72cm
3	HUN - Hungary	7	5	2	Q	w0	DSC 55.87cm
4	SWE - Sweden	7	4	3	Q		DSC 40.72cm
5	KAZ - Kazakhstan	7	3	4		w1	
6	AUS - Australia	7	3	4		w0	
7	LAT - Latvia	7	1	6			
8	BRA - Brazil	7	0	7			

Competition Matrix

Group D

Team	IRL	ITA	JPN	LUX	SCO	SLO	TPE	TUR
IRL		7 - 6	9 - 3	10 - 2	3 - 7	8 - 5	6 - 4	3 - 5
ITA	6 - 7		7 - 4	14 - 1	2 - 7	7 - 5	10 - 2	5 - 8
JPN	3 - 9	4 - 7		11 - 3	4 - 5	11 - 5	10 - 1	5 - 2
LUX	2 - 10	1 - 14	3 - 11		3 - 12	2 - 11	2 - 5	3 - 10
SCO	7 - 3	7 - 2	5 - 4	12 - 3		8 - 6	11 - 4	5 - 3
SLO	5 - 8	5 - 7	5 - 11	11 - 2	6 - 8		6 - 3	5 - 6
TPE	4 - 6	2 - 10	1 - 10	5 - 2	4 - 11	3 - 6		9 - 7
TUR	5 - 3	8 - 5	2 - 5	10 - 3	3 - 5	6 - 5	7 - 9	

Standings after Round Robin

Rank	Team	Games	Wins	Losses			
1	SCO - Scotland	7	7	0	Q		DSC 48.13cm
2	IRL - Ireland	7	5	2	Q		DSC 79.85cm
3	TUR - Turkey	7	4	3	Q	w1	DSC 69.22cm
4	ITA - Italy	7	4	3		w1	DSC 70.13cm
5	JPN - Japan	7	4	3		w1	DSC 70.29cm
6	SLO - Slovenia	7	2	5		w1	
7	TPE - Chinese Taipei	7	2	5		w0	
8	LUX - Luxembourg	7	0	7			

Competition Matrix

Group E

Team	AUT	BEL	ENG	FIN	FRA	KOR	RUS	SUI
AUT		5 - 4	4 - 7	0 - 8	4 - 7	2 - 9	2 - 11	2 - 7
BEL	4 - 5		1 - 13	5 - 12	2 - 10	3 - 12	3 - 10	3 - 6
ENG	7 - 4	13 - 1		3 - 8	5 - 4	2 - 7	3 - 9	1 - 7
FIN	8 - 0	12 - 5	8 - 3		10 - 4	6 - 7	5 - 7	5 - 9
FRA	7 - 4	10 - 2	4 - 5	4 - 10		5 - 6	2 - 9	2 - 6
KOR	9 - 2	12 - 3	7 - 2	7 - 6	6 - 5		2 - 10	3 - 5
RUS	11 - 2	10 - 3	9 - 3	7 - 5	9 - 2	10 - 2		6 - 3
SUI	7 - 2	6 - 3	7 - 1	9 - 5	6 - 2	5 - 3	3 - 6	

Standings after Round Robin

Rank	Team	Games	Wins	Losses		
1	RUS - Russia	7	7	0	Q	DSC 43.10cm
2	SUI - Switzerland	7	6	1	Q	DSC 43.48cm
3	KOR - Korea	7	5	2	Q	DSC 71.57cm
4	FIN - Finland	7	4	3		DSC 87.28cm
5	ENG - England	7	3	4		
6	FRA - France	7	2	5		
7	AUT - Austria	7	1	6		
8	BEL - Belgium	7	0	7		

Legend:			
DSC Draw Shot Challenge	L Loss	Q Qualified for the play-offs	
W Win	wn Number of wins (n) against tied teams		

After Round Robin

Draw Shot Challenge

Group A		Stone Rotation	Last Stone Draw in each Round Robin Game							DSC
Rank	Team		1	2	3	4	5	6	7	
1	CAN - Canada	↻	12.7	57.3	52.6	94.2	13.3	23.4	48.4	31.72cm
		↻	134.6	14.4	62.2	21.3	15.2	40.4	19.4	
2	GER - Germany	↻	33.9	15.2	29.4	25.3	13.6	199.6	118.3	37.42cm
		↻	39.7	28.9	166.6	21.6	77.8	4.6	40.7	
3	BLR - Belarus	↻	84.3	199.6	49.3	8.8	25.8	64.4	5.3	52.03cm
		↻	5.4	76.3	93.9	97.7	67.2	45.9	199.6	
4	HKG - Hong Kong	↻	137.5	199.6	41.7	17.7	173.0	54.8	67.2	59.24cm
		↻	78.7	21.7	66.7	60.8	10.5	79.3	74.3	
5	SVK - Slovakia	↻	23.6	139.0	52.7	111.4	16.0	18.7	73.0	59.37cm
		↻	199.6	51.3	28.4	121.7	29.0	151.9	47.6	
6	EST - Estonia	↻	199.6	199.6	37.3	45.5	50.4	199.6	53.4	108.77cm
		↻	199.6	97.8	199.6	153.7	199.6	41.1	27.6	
7	NGR - Nigeria	↻	146.0	199.6	184.3	53.2	129.0	199.6	15.3	116.77cm
		↻	199.6	178.0	63.2	85.6	27.2	199.6	120.2	
8	KOS - Kosovo	↻	146.0	199.6	8.1	199.6	148.2	97.3	168.3	131.82cm
		↻	199.6	72.5	6.8	199.6	189.5	199.6	146.3	

Group B		Stone Rotation	Last Stone Draw in each Round Robin Game							DSC
Rank	Team		1	2	3	4	5	6	7	
1	POL - Poland	↻	88.5	15.6	80.6	78.3	199.6	7.5	68.2	55.05cm
		↻	29.0	186.3	48.5	19.9	53.7	13.4	157.4	
2	CZE - Czech Republic	↻	58.5	73.5	47.6	25.6	94.4	70.1	102.7	63.50cm
		↻	53.9	46.7	33.0	150.1	122.5	33.5	155.2	
3	NOR - Norway	↻	111.1	49.5	199.6	133.1	32.2	80.2	66.4	68.56cm
		↻	52.7	20.0	115.4	7.8	53.0	152.7	101.3	
4	DEN - Denmark	↻	102.3	39.8	30.2	199.6	17.8	65.5	27.7	70.81cm
		↻	105.9	57.9	115.7	199.6	199.6	31.5	55.8	
5	WAL - Wales	↻	199.6	18.3	54.2	43.2	24.9	129.5	111.2	85.10cm
		↻	199.6	118.1	199.6	97.0	18.8	48.7	157.7	
6	NZL - New Zealand	↻	135.5	114.9	195.4	37.4	68.3	199.6	99.9	95.66cm
		↻	199.6	116.1	85.9	63.7	68.1	42.2	120.5	
7	AND - Andorra	↻	13.5	90.5	199.6	199.6	149.6	58.5	172.1	133.73cm
		↻	84.0	199.6	72.4	199.6	199.6	165.8	199.6	
8	CRO - Croatia	↻	199.6	199.6	104.4	21.6	154.5	199.6	135.2	152.87cm
		↻	199.6	199.6	185.9	147.9	199.6	86.9	199.6	



After Round Robin

Draw Shot Challenge

Group C		Stone Rotation	Last Stone Draw in each Round Robin Game							DSC
Rank	Team		1	2	3	4	5	6	7	
1	SWE - Sweden	☺	135.3	61.5	21.2	33.3	31.0	27.9	21.5	40.72cm
		☹	76.0	29.4	199.6	17.7	95.7	21.8	51.6	
2	KAZ - Kazakhstan	☺	45.0	19.5	16.6	32.7	87.3	65.2	144.6	46.28cm
		☹	68.7	14.8	20.0	48.9	100.3	199.6	36.3	
3	AUS - Australia	☺	77.0	56.5	29.0	91.8	66.1	115.9	7.7	48.31cm
		☹	34.6	81.1	37.5	21.8	53.2	23.4	119.0	
4	HUN - Hungary	☺	174.3	199.6	17.7	58.5	23.8	57.0	50.7	55.87cm
		☹	38.2	17.7	99.7	29.1	34.7	199.6	69.0	
5	LAT - Latvia	☺	23.1	199.6	77.4	97.5	16.7	6.4	118.3	66.73cm
		☹	22.4	199.6	49.1	161.0	124.6	28.6	75.6	
6	ESP - Spain	☺	53.8	140.5	13.5	35.3	19.5	49.5	42.5	72.28cm
		☹	137.7	145.3	199.6	100.1	110.1	19.6	190.0	
7	USA - United States	☺	22.3	67.0	154.1	80.4	199.6	115.1	140.2	84.72cm
		☹	8.1	79.0	62.1	66.9	72.3	199.6	149.1	
8	BRA - Brazil	☺	187.0	61.9	199.6	30.3	19.0	55.4	97.5	91.99cm
		☹	56.2	83.1	100.5	167.0	46.4	199.6	199.6	

Group D		Stone Rotation	Last Stone Draw in each Round Robin Game							DSC
Rank	Team		1	2	3	4	5	6	7	
1	SCO - Scotland	☺	23.3	26.1	37.3	34.2	143.9	29.6	29.4	48.13cm
		☹	8.7	199.6	125.5	16.0	101.6	100.3	45.6	
2	TUR - Turkey	☺	44.4	66.9	105.4	80.6	45.8	199.6	19.2	69.22cm
		☹	58.8	15.0	153.4	23.7	24.4	199.6	193.0	
3	ITA - Italy	☺	122.3	85.0	61.0	36.0	55.8	23.6	22.5	70.13cm
		☹	41.4	145.4	60.5	199.6	176.3	143.8	44.2	
4	JPN - Japan	☺	39.7	199.6	164.4	56.8	49.2	38.0	29.4	70.29cm
		☹	158.3	73.9	14.2	51.9	115.6	52.1	166.5	
5	IRL - Ireland	☺	119.2	138.0	199.6	148.1	50.8	34.1	17.2	79.85cm
		☹	151.7	37.5	43.1	199.6	151.2	25.0	42.3	
6	SLO - Slovenia	☺	50.5	89.5	20.6	185.5	199.6	31.8	107.0	82.85cm
		☹	119.7	49.3	39.2	174.3	164.6	9.0	138.7	
7	TPE - Chinese Taipei	☺	51.3	56.6	90.1	90.2	145.8	70.8	132.7	96.72cm
		☹	32.4	47.0	199.6	199.6	148.3	95.8	199.6	
8	LUX - Luxembourg	☺	199.6	199.6	71.2	191.1	95.5	4.2	29.4	113.44cm
		☹	157.6	75.7	199.6	199.6	199.6	83.1	54.7	

Draw Shot Challenge

Group E		Stone Rotation	Last Stone Draw in each Round Robin Game							DSC
Rank	Team		1	2	3	4	5	6	7	
1	RUS - Russia	↻	21.9	51.2	24.1	23.6	97.2	7.6	40.5	43.10cm
		↻	102.2	107.9	38.9	73.8	101.3	9.6	27.5	
2	SUI - Switzerland	↻	87.5	40.0	9.8	117.6	60.6	12.1	55.3	43.48cm
		↻	41.0	20.1	64.6	87.0	9.5	107.4	34.2	
3	ENG - England	↻	77.7	57.2	6.9	89.7	40.3	199.6	31.9	49.97cm
		↻	71.2	54.8	69.3	28.5	86.1	42.7	33.0	
4	KOR - Korea	↻	94.0	146.5	120.7	42.8	103.0	86.1	37.9	71.57cm
		↻	172.5	199.6	31.1	89.1	28.3	59.7	19.6	
5	AUT - Austria	↻	93.9	199.6	53.9	178.9	55.3	199.6	34.6	84.58cm
		↻	23.0	27.6	199.6	117.9	11.5	199.6	19.2	
6	FIN - Finland	↻	63.9	163.5	142.4	186.2	134.3	88.8	86.1	87.28cm
		↻	30.1	4.2	71.6	19.5	97.2	175.4	145.7	
7	FRA - France	↻	156.6	177.5	37.1	16.1	199.6	199.6	199.6	119.87cm
		↻	53.9	112.9	199.6	94.1	70.1	148.3	172.6	
8	BEL - Belgium	↻	199.6	39.8	199.6	182.5	159.4	199.6	125.5	145.71cm
		↻	30.9	199.6	136.2	186.9	199.6	88.9	199.6	

Note:

The Draw Shot Challenge (DSC) is the average distance of all the individual Last Stone Draws (LSD), which were delivered by a team during the round robin. The two least favourable results will be eliminated before calculating the average distance. The team with the lesser DSC receives the higher ranking. If the DSCs are equal then the team with the best non-equal counting LSD receives the higher ranking. In the case where all counting LSDs are equal, the team ranked higher in the WCF World Rankings is ranked higher.

Legend:

↻ Clockwise

↻ Counter-clockwise

DSC Draw Shot Challenge

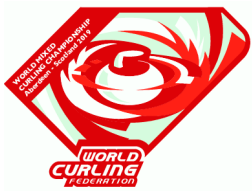

Scoring Analysis

Team	Games		LSFE	Stolen Ends	Last Stone Eff.	Force Eff.	Points Scored						Total	Plus / Minus
							0	1	2	3	4	>4		
GER	7	For	5	17	44%	58%	2	14	8	2	4	3	68	+46
		Against	2	2			2	8	4	2	0	0	22	
CAN	7	For	4	12	78%	80%	1	9	9	4	4	2	65	+44
		Against	3	2			3	14	2	1	0	0	21	
NOR	7	For	5	22	53%	64%	0	16	11	5	2	1	66	+44
		Against	2	2			0	7	5	0	0	1	22	
RUS	7	For	7	10	59%	82%	2	7	11	5	3	1	62	+42
		Against	0	5			0	12	4	0	0	0	20	
DEN	7	For	5	12	55%	77%	3	12	11	3	3	0	55	+35
		Against	2	3			0	13	2	1	0	0	20	
POL	7	For	5	11	55%	62%	1	13	8	4	2	1	54	+32
		Against	2	3			2	10	6	0	0	0	22	
SCO	7	For	5	8	54%	71%	1	11	7	7	1	1	55	+30
		Against	2	5			1	14	4	1	0	0	25	
CZE	7	For	5	10	60%	46%	1	9	11	4	1	1	52	+26
		Against	2	4			3	9	7	1	0	0	26	
ESP	7	For	2	12	53%	64%	0	9	9	6	1	0	49	+26
		Against	5	4			6	13	5	0	0	0	23	
HUN	7	For	5	11	48%	60%	1	15	7	4	2	1	54	+23
		Against	2	5			0	13	4	2	1	0	31	
SUI	7	For	4	14	53%	54%	4	17	8	2	1	0	43	+21
		Against	3	1			4	8	4	2	0	0	22	
BLR	7	For	5	14	17%	67%	2	12	7	3	1	2	50	+20
		Against	2	13			2	16	5	0	1	0	30	
FIN	7	For	3	13	55%	36%	2	13	6	8	0	1	54	+19
		Against	4	5			1	9	7	0	3	0	35	
USA	7	For	1	10	60%	59%	2	8	14	2	2	0	50	+18
		Against	6	4			1	13	5	3	0	0	32	
ITA	7	For	5	10	30%	56%	2	14	7	3	1	2	51	+17
		Against	2	6			1	13	6	3	0	0	34	
JPN	7	For	5	8	47%	50%	5	13	6	1	2	2	48	+16
		Against	2	3			0	9	8	1	1	0	32	
EST	7	For	1	14	13%	50%	3	14	4	2	4	1	51	+15
		Against	6	12			0	12	8	0	2	0	36	
HKG	7	For	5	12	38%	60%	1	17	5	5	1	0	46	+14
		Against	2	8			1	15	7	1	0	0	32	
IRL	7	For	3	9	38%	76%	0	14	7	2	3	0	46	+14
		Against	4	7			2	19	3	1	1	0	32	



Scoring Analysis

Team	Games		LSFE	Stolen Ends	Last Stone Eff.	Force Eff.	Points Scored						Total	Plus / Minus
							0	1	2	3	4	>4		
KOR	7	For	4	8	41%	53%	3	12	6	6	1	0	46	+13
		Against	3	5			2	11	6	2	1	0	33	
SVK	7	For	2	13	50%	36%	3	10	11	1	1	0	39	+12
		Against	4	2			3	5	4	3	0	1	27	
SWE	7	For	5	6	39%	41%	3	13	9	1	1	1	43	+7
		Against	2	4			0	10	9	0	2	0	36	
TUR	7	For	3	7	27%	63%	3	13	7	3	0	1	41	+6
		Against	4	9			4	16	8	1	0	0	35	
KAZ	7	For	4	8	43%	39%	1	10	9	4	2	0	48	+5
		Against	3	6			1	10	10	3	1	0	43	
AUS	7	For	6	9	27%	43%	2	15	7	3	1	0	42	+3
		Against	1	9			2	13	6	2	2	0	39	
SLO	7	For	3	8	35%	42%	0	16	8	1	2	0	43	-2
		Against	4	4			1	10	7	3	3	0	45	
ENG	7	For	3	8	17%	60%	0	10	7	2	1	0	34	-6
		Against	4	12			1	17	7	3	0	0	40	
FRA	7	For	3	7	18%	50%	1	16	5	0	2	0	34	-8
		Against	4	6			2	12	8	3	0	1	42	
NZL	7	For	3	6	19%	33%	3	9	6	1	1	1	33	-16
		Against	4	14			0	15	8	6	0	0	49	
LAT	7	For	4	4	30%	40%	2	10	5	1	1	1	32	-22
		Against	3	13			1	12	7	8	1	0	54	
TPE	7	For	3	10	12%	62%	0	16	3	2	0	0	28	-24
		Against	4	15			1	17	4	4	1	2	52	
WAL	7	For	2	5	22%	29%	1	13	5	0	1	0	27	-24
		Against	5	9			4	9	12	3	1	1	51	
AUT	7	For	4	4	3%	50%	0	14	1	1	0	0	19	-34
		Against	3	17			1	14	7	7	1	0	53	
BEL	7	For	0	1	22%	39%	0	7	7	0	0	0	21	-47
		Against	7	14			1	13	8	7	3	1	68	
AND	7	For	3	2	6%	36%	0	9	2	0	0	0	13	-48
		Against	4	22			0	17	9	3	3	1	61	
CRO	7	For	0	5	15%	33%	0	9	5	0	0	1	24	-49
		Against	7	16			0	10	10	3	6	2	73	
KOS	7	For	2	5	13%	10%	0	9	4	0	0	0	17	-52
		Against	4	15			1	6	6	6	4	3	69	
LUX	7	For	1	2	8%	24%	0	12	2	0	0	0	16	-57
		Against	6	13			1	11	7	5	3	4	73	

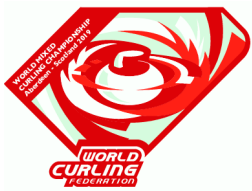

Scoring Analysis

Team	Games		LSFE	Stolen Ends	Last Stone Eff.	Force Eff.	Points Scored						Total	Plus / Minus
							0	1	2	3	4	>4		
BRA	7	For	1	1	7%	20%	0	10	2	0	0	0	14	-60
		Against	6	16			0	6	16	3	3	3	74	
NGR	7	For	3	0	3%	0%	0	4	0	1	0	0	7	-99
		Against	4	33			0	13	12	5	8	4	106	
Total	140			348			55	474	267	99	52	24	1640	

Note:
 Stolen ends are the ends won without the last stone advantage.
 Last Stone Efficiency: Scoring two or more points with last stone advantage.
 Force Efficiency: Forcing the opponent team to score only one point when they have the last stone advantage.

Legend:
 >4 More than four points scored **Eff.** Efficiency **LSFE** Last Stone First End





Summary of Big Ends

Points Scored	By	Against	Session	End	Game Result
7	EST - Estonia	KOS - Kosovo	11	5	18 : 1
6	BLR - Belarus	NGR - Nigeria	23	7	19 : 1
6	GER - Germany	NGR - Nigeria	20	4	21 : 1
6	JPN - Japan	LUX - Luxembourg	2	6	11 : 3
6	JPN - Japan	TPE - Chinese Taipei	15	1	10 : 1
6	RUS - Russia	BEL - Belgium	15	6	10 : 3
5	BLR - Belarus	NGR - Nigeria	23	2	19 : 1
5	CAN - Canada	KOS - Kosovo	23	1	17 : 3
5	CAN - Canada	KOS - Kosovo	23	3	17 : 3
5	CRO - Croatia	WAL - Wales	5	5	6 : 8
5	CZE - Czech Republic	CRO - Croatia	14	1	12 : 2
5	FIN - Finland	FRA - France	7	6	10 : 4
5	GER - Germany	SVK - Slovakia	6	4	10 : 3
5	GER - Germany	NGR - Nigeria	20	1	21 : 1
5	HUN - Hungary	BRA - Brazil	1	3	14 : 2
5	ITA - Italy	TPE - Chinese Taipei	10	7	10 : 2
5	ITA - Italy	LUX - Luxembourg	17	1	14 : 1
5	LAT - Latvia	BRA - Brazil	24	3	11 : 3
5	NOR - Norway	AND - Andorra	17	6	15 : 0
5	NZL - New Zealand	NOR - Norway	5	4	5 : 10
5	POL - Poland	CRO - Croatia	8	3	15 : 1
5	SCO - Scotland	LUX - Luxembourg	7	1	12 : 3
5	SWE - Sweden	BRA - Brazil	20	6	10 : 2
5	TUR - Turkey	LUX - Luxembourg	15	4	10 : 3
4	AUS - Australia	HUN - Hungary	19	1	5 : 6
4	BLR - Belarus	EST - Estonia	16	4	8 : 6
4	CAN - Canada	NGR - Nigeria	18	1	15 : 1
4	CAN - Canada	NGR - Nigeria	18	5	15 : 1
4	CAN - Canada	EST - Estonia	21	5	7 : 2
4	CAN - Canada	KOS - Kosovo	23	6	17 : 3
4	CZE - Czech Republic	AND - Andorra	5	5	11 : 1
4	DEN - Denmark	WAL - Wales	8	5	14 : 1
4	DEN - Denmark	CRO - Croatia	17	1	12 : 3
4	DEN - Denmark	CRO - Croatia	17	6	12 : 3
4	ENG - England	BEL - Belgium	19	3	13 : 1
4	ESP - Spain	KAZ - Kazakhstan	16	5	7 : 4
4	EST - Estonia	NGR - Nigeria	1	1	16 : 1
4	EST - Estonia	NGR - Nigeria	1	7	16 : 1



Summary of Big Ends

Points Scored	By	Against	Session	End	Game Result
4	EST - Estonia	KOS - Kosovo	11	1	18 : 1
4	EST - Estonia	BLR - Belarus	16	1	6 : 8
4	FRA - France	FIN - Finland	7	4	4 : 10
4	FRA - France	BEL - Belgium	17	4	10 : 2
4	GER - Germany	KOS - Kosovo	16	1	14 : 1
4	GER - Germany	KOS - Kosovo	16	4	14 : 1
4	GER - Germany	NGR - Nigeria	20	3	21 : 1
4	GER - Germany	NGR - Nigeria	20	6	21 : 1
4	HKG - Hong Kong	NGR - Nigeria	11	1	12 : 0
4	HUN - Hungary	BRA - Brazil	1	1	14 : 2
4	HUN - Hungary	SWE - Sweden	9	4	9 : 3
4	IRL - Ireland	SLO - Slovenia	2	5	8 : 5
4	IRL - Ireland	JPN - Japan	10	5	9 : 3
4	IRL - Ireland	LUX - Luxembourg	19	4	10 : 2
4	ITA - Italy	IRL - Ireland	4	5	6 : 7
4	JPN - Japan	SLO - Slovenia	22	1	11 : 5
4	JPN - Japan	SLO - Slovenia	22	3	11 : 5
4	KAZ - Kazakhstan	LAT - Latvia	1	6	12 : 5
4	KAZ - Kazakhstan	BRA - Brazil	11	2	10 : 2
4	KOR - Korea	BEL - Belgium	7	7	12 : 3
4	LAT - Latvia	AUS - Australia	6	4	5 : 7
4	NOR - Norway	CRO - Croatia	12	2	16 : 0
4	NOR - Norway	CRO - Croatia	12	4	16 : 0
4	NZL - New Zealand	AND - Andorra	8	3	9 : 2
4	POL - Poland	CRO - Croatia	8	1	15 : 1
4	POL - Poland	CRO - Croatia	8	5	15 : 1
4	RUS - Russia	AUT - Austria	7	1	11 : 2
4	RUS - Russia	KOR - Korea	10	5	10 : 2
4	RUS - Russia	FIN - Finland	19	5	7 : 5
4	SCO - Scotland	TPE - Chinese Taipei	13	6	11 : 4
4	SLO - Slovenia	LUX - Luxembourg	9	5	11 : 2
4	SLO - Slovenia	LUX - Luxembourg	9	7	11 : 2
4	SUI - Switzerland	FIN - Finland	15	7	9 : 5
4	SVK - Slovakia	NGR - Nigeria	16	5	14 : 0
4	SWE - Sweden	AUS - Australia	3	4	8 : 5
4	USA - United States	BRA - Brazil	5	3	12 : 2
4	USA - United States	SWE - Sweden	14	4	8 : 3
4	WAL - Wales	AND - Andorra	14	3	7 : 5



THU 17 OCT 2019
Start Time 20:00

Round Robin Session 24

Session Results and Standings

Sheet	Game	Team	LSFE	1	2	3	4	5	6	7	8	Extra	Ends	Total
A	7	TUR - Turkey		0	2	0	0	0	1	0	2	0	3	8
	7	ITA - Italy	*	1	0	1	1	1	0	1	0	0	0	5
B	7	BRA - Brazil		0	2	0	1	0	0	X	X			3
	7	LAT - Latvia	*	3	0	5	0	2	1	X	X			11
C	7	FIN - Finland		1	3	1	1	1	1	X	X			8
	7	AUT - Austria	*	0	0	0	0	0	0	X	X			0
D	7	ESP - Spain		0	0	0	3	2	1	0	1			7
	7	HUN - Hungary	*	0	2	1	0	0	0	2	0			5
E	7	SCO - Scotland		0	0	3	1	0	2	1	X			7
	7	IRL - Ireland	*	1	1	0	0	1	0	0	X			3
F	7	RUS - Russia	*	2	0	2	0	2	3	X	X			9
	7	FRA - France		0	1	0	1	0	0	X	X			2

Standings after Round Robin

Group A

Rank	Team	Games	Wins	Losses	Q	DSC	31.72cm
1	CAN - Canada	7	7	0	Q	DSC	31.72cm
2	GER - Germany	7	5	2	Q w1	DSC	37.42cm
3	SVK - Slovakia	7	5	2	Q w0	DSC	59.37cm
4	BLR - Belarus	7	4	3	w1	DSC	52.03cm
5	HKG - Hong Kong	7	4	3	w0		
6	EST - Estonia	7	2	5			
7	KOS - Kosovo	7	1	6			
8	NGR - Nigeria	7	0	7			

Group B

Rank	Team	Games	Wins	Losses	Q	DSC	68.56cm
1	NOR - Norway	7	6	1	Q w1	DSC	68.56cm
2	DEN - Denmark	7	6	1	Q w0	DSC	70.81cm
3	POL - Poland	7	5	2	Q w1	DSC	55.05cm
4	CZE - Czech Republic	7	5	2	w0	DSC	63.50cm
5	WAL - Wales	7	3	4			
6	NZL - New Zealand	7	2	5			
7	CRO - Croatia	7	1	6			
8	AND - Andorra	7	0	7			

Group C

Rank	Team	Games	Wins	Losses	Q	DSC	72.28cm
1	ESP - Spain	7	7	0	Q	DSC	72.28cm
2	USA - United States	7	5	2	Q w1	DSC	84.72cm
3	HUN - Hungary	7	5	2	Q w0	DSC	55.87cm
4	SWE - Sweden	7	4	3	Q	DSC	40.72cm
5	KAZ - Kazakhstan	7	3	4	w1		
6	AUS - Australia	7	3	4	w0		
7	LAT - Latvia	7	1	6			
8	BRA - Brazil	7	0	7			

Group D

Rank	Team	Games	Wins	Losses	Q	DSC	48.13cm
1	SCO - Scotland	7	7	0	Q	DSC	48.13cm
2	IRL - Ireland	7	5	2	Q	DSC	79.85cm
3	TUR - Turkey	7	4	3	Q w1	DSC	69.22cm
4	ITA - Italy	7	4	3	w1	DSC	70.13cm
5	JPN - Japan	7	4	3	w1	DSC	70.29cm
6	SLO - Slovenia	7	2	5	w1		
7	TPE - Chinese Taipei	7	2	5	w0		
8	LUX - Luxembourg	7	0	7			

Group E

Rank	Team	Games	Wins	Losses	Q	DSC	43.10cm
1	RUS - Russia	7	7	0	Q	DSC	43.10cm
2	SUI - Switzerland	7	6	1	Q	DSC	43.48cm
3	KOR - Korea	7	5	2	Q	DSC	71.57cm
4	FIN - Finland	7	4	3		DSC	87.28cm
5	ENG - England	7	3	4			
6	FRA - France	7	2	5			
7	AUT - Austria	7	1	6			
8	BEL - Belgium	7	0	7			

Legend:

DSC Draw Shot Challenge **LSFE(*)** Last Stone First End **Q** Qualified for the play-offs
wn Number of wins (n) against tied teams **X** Unplayed/unfinished end due to concession



THU 17 OCT 2019
Start Time 16:00

Round Robin Session 23

Session Results and Standings

Sheet	Game	Team	LSFE	1	2	3	4	5	6	7	8	Extra Ends	Total
A	7	EST - Estonia	*	0	0	0	0	0	1	X	X		1
	7	SVK - Slovakia		2	0	2	2	1	0	X	X		7
B	7	KOS - Kosovo		0	1	0	0	2	0	X	X		3
	7	CAN - Canada	*	5	0	5	3	0	4	X	X		17
C	7	NGR - Nigeria	*	0	0	0	0	0	1	0	X		1
	7	BLR - Belarus		2	5	2	1	3	0	6	X		19
D	7	KAZ - Kazakhstan		0	1	0	2	0	0	2	0		5
	7	SWE - Sweden	*	1	0	1	0	2	2	0	1		7
E	7	AUS - Australia	*	3	0	1	0	2	0	0	1		7
	7	USA - United States		0	1	0	2	0	1	1	0		5
F	7	GER - Germany		0	1	0	1	0	1	2	1		6
	7	HKG - Hong Kong	*	3	0	3	0	1	0	0	0		7

Current Standings

Group A

Rank	Team	Games	Wins	Losses	
1	CAN - Canada	7	7	0	Q
2	GER - Germany	7	5	2	Q w1
3	SVK - Slovakia	7	5	2	Q w0
4	BLR - Belarus	7	4	3	w1
5	HKG - Hong Kong	7	4	3	w0
6	EST - Estonia	7	2	5	
7	KOS - Kosovo	7	1	6	
8	NGR - Nigeria	7	0	7	

Group B

Rank	Team	Games	Wins	Losses	
1	NOR - Norway	7	6	1	Q w1
2	DEN - Denmark	7	6	1	Q w0
3	POL - Poland	7	5	2	Q w1
4	CZE - Czech Republic	7	5	2	w0
5	WAL - Wales	7	3	4	
6	NZL - New Zealand	7	2	5	
7	CRO - Croatia	7	1	6	
8	AND - Andorra	7	0	7	

Group C

Rank	Team	Games	Wins	Losses	
1	ESP - Spain	6	6	0	Q
2	HUN - Hungary	6	5	1	Q
3	USA - United States	7	5	2	Q
4	SWE - Sweden	7	4	3	Q
5	AUS - Australia	7	3	4	DSC 40.72cm
5	KAZ - Kazakhstan	7	3	4	
7	BRA - Brazil	6	0	6	
7	LAT - Latvia	6	0	6	

Group D

Rank	Team	Games	Wins	Losses	
1	SCO - Scotland	6	6	0	Q
2	IRL - Ireland	6	5	1	Q
3	ITA - Italy	6	4	2	
4	JPN - Japan	7	4	3	
5	TUR - Turkey	6	3	3	
6	SLO - Slovenia	7	2	5	
6	TPE - Chinese Taipei	7	2	5	
8	LUX - Luxembourg	7	0	7	

Group E

Rank	Team	Games	Wins	Losses	
1	RUS - Russia	6	6	0	Q
2	SUI - Switzerland	7	6	1	Q
3	KOR - Korea	7	5	2	Q
4	FIN - Finland	6	3	3	
5	ENG - England	7	3	4	
6	FRA - France	6	2	4	
7	AUT - Austria	6	1	5	
8	BEL - Belgium	7	0	7	

Legend:	DSC Draw Shot Challenge	LSFE(*) Last Stone First End	Q Qualified for the play-offs
	wn Number of wins (n) against tied teams	X Unplayed/unfinished end due to concession	

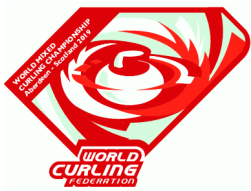

THU 17 OCT 2019
Start Time 12:00

Round Robin Session 22

Session Results and Standings

Sheet	Game	Team	LSFE	1	2	3	4	5	6	7	8	Extra Ends	Total
A	7	WAL - Wales		0	0	1	0	0	0	0	X		1
	7	NOR - Norway	*	1	1	0	1	1	3	2	X		9
B	7	KOR - Korea	*	3	0	1	2	0	1	X	X		7
	7	ENG - England		0	1	0	0	1	0	X	X		2
C	7	AND - Andorra		0	0	1	0	0	0	X	X		1
	7	POL - Poland	*	2	1	0	1	2	1	X	X		7
D	7	JPN - Japan	*	4	0	4	0	3	0	X	X		11
	7	SLO - Slovenia		0	1	0	2	0	2	X	X		5
E	7	DEN - Denmark	*	0	0	0	2	1	3	0	X		6
	7	CZE - Czech Republic		0	0	0	0	0	0	1	X		1
F	6	ESP - Spain	*	2	0	1	3	1	0	X	X		7
	6	BRA - Brazil		0	1	0	0	0	1	X	X		2

Current Standings

Group A

Rank	Team	Games	Wins	Losses	
1	CAN - Canada	6	6	0	Q
2	GER - Germany	6	5	1	Q
3	SVK - Slovakia	6	4	2	Q
4	BLR - Belarus	6	3	3	
4	HKG - Hong Kong	6	3	3	
6	EST - Estonia	6	2	4	
7	KOS - Kosovo	6	1	5	
8	NGR - Nigeria	6	0	6	

Group B

Rank	Team	Games	Wins	Losses	
1	NOR - Norway	7	6	1	Q w1 DSC 68.56cm
2	DEN - Denmark	7	6	1	Q w0 DSC 70.81cm
3	POL - Poland	7	5	2	Q w1 DSC 55.05cm
4	CZE - Czech Republic	7	5	2	w0 DSC 63.50cm
5	WAL - Wales	7	3	4	
6	NZL - New Zealand	7	2	5	
7	CRO - Croatia	7	1	6	
8	AND - Andorra	7	0	7	

Group C

Rank	Team	Games	Wins	Losses	
1	ESP - Spain	6	6	0	Q
2	HUN - Hungary	6	5	1	Q
2	USA - United States	6	5	1	Q
4	KAZ - Kazakhstan	6	3	3	
4	SWE - Sweden	6	3	3	
6	AUS - Australia	6	2	4	
7	BRA - Brazil	6	0	6	
7	LAT - Latvia	6	0	6	

Group D

Rank	Team	Games	Wins	Losses	
1	SCO - Scotland	6	6	0	Q
2	IRL - Ireland	6	5	1	Q
3	ITA - Italy	6	4	2	
4	JPN - Japan	7	4	3	
5	TUR - Turkey	6	3	3	
6	SLO - Slovenia	7	2	5	
6	TPE - Chinese Taipei	7	2	5	
8	LUX - Luxembourg	7	0	7	

Group E

Rank	Team	Games	Wins	Losses	
1	RUS - Russia	6	6	0	Q
2	SUI - Switzerland	7	6	1	Q
3	KOR - Korea	7	5	2	Q
4	FIN - Finland	6	3	3	
5	ENG - England	7	3	4	
6	FRA - France	6	2	4	
7	AUT - Austria	6	1	5	
8	BEL - Belgium	7	0	7	

Legend:

DSC Draw Shot Challenge **LSFE(*)** Last Stone First End **Q** Qualified for the play-offs
wn Number of wins (n) against tied teams **X** Unplayed/unfinished end due to concession

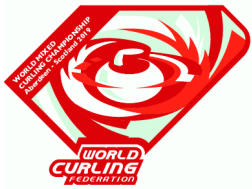

THU 17 OCT 2019
Start Time 8:00

Round Robin Session 21

Session Results and Standings

Sheet	Game	Team	LSFE	1	2	3	4	5	6	7	8	Extra Ends	Total
B	7	LUX - Luxembourg	*	1	1	0	0	0	0	0	X		2
	7	TPE - Chinese Taipei		0	0	1	1	1	1	1	X		5
C	6	HKG - Hong Kong	*	0	0	2	0	2	1	1	X		6
	6	KOS - Kosovo		0	1	0	1	0	0	0	X		2
D	6	CAN - Canada	*	2	1	0	0	4	0	X	X		7
	6	EST - Estonia		0	0	0	1	0	1	X	X		2
E	7	BEL - Belgium		0	0	0	0	1	0	2	X		3
	7	SUI - Switzerland	*	1	1	1	1	0	2	0	X		6
F	7	NZL - New Zealand	*	1	3	0	0	0	1	2	0		7
	7	CRO - Croatia		0	0	1	2	1	0	0	2		6

Current Standings

Group A					Group B				
Rank	Team	Games	Wins	Losses	Rank	Team	Games	Wins	Losses
1	CAN - Canada	6	6	0	1	CZE - Czech Republic	6	5	1
2	GER - Germany	6	5	1	1	DEN - Denmark	6	5	1
3	SVK - Slovakia	6	4	2	1	NOR - Norway	6	5	1
4	BLR - Belarus	6	3	3	4	POL - Poland	6	4	2
4	HKG - Hong Kong	6	3	3	5	WAL - Wales	6	3	3
6	EST - Estonia	6	2	4	6	NZL - New Zealand	7	2	5
7	KOS - Kosovo	6	1	5	7	CRO - Croatia	7	1	6
8	NGR - Nigeria	6	0	6	8	AND - Andorra	6	0	6
Group C					Group D				
Rank	Team	Games	Wins	Losses	Rank	Team	Games	Wins	Losses
1	ESP - Spain	5	5	0	1	SCO - Scotland	6	6	0
2	HUN - Hungary	6	5	1	2	IRL - Ireland	6	5	1
2	USA - United States	6	5	1	3	ITA - Italy	6	4	2
4	KAZ - Kazakhstan	6	3	3	4	JPN - Japan	6	3	3
4	SWE - Sweden	6	3	3	4	TUR - Turkey	6	3	3
6	AUS - Australia	6	2	4	6	SLO - Slovenia	6	2	4
7	BRA - Brazil	5	0	5	7	TPE - Chinese Taipei	7	2	5
8	LAT - Latvia	6	0	6	8	LUX - Luxembourg	7	0	7
Group E									
Rank	Team	Games	Wins	Losses					
1	RUS - Russia	6	6	0					
2	SUI - Switzerland	7	6	1					
3	KOR - Korea	6	4	2					
4	ENG - England	6	3	3					
4	FIN - Finland	6	3	3					
6	FRA - France	6	2	4					
7	AUT - Austria	6	1	5					
8	BEL - Belgium	7	0	7					

Note:
Under WCF rules, tie-breaking rules for standings are not applied until after the last game of the round robin.

Legend:
LSFE(*) Last Stone First End **Q** Qualified for the play-offs **X** Unplayed/unfinished end due to concession



WED 16 OCT 2019
Start Time 20:00

Round Robin Session 20

Session Results and Standings

Sheet	Game	Team	LSFE	1	2	3	4	5	6	7	8	Extra Ends	Total
A	6	SWE - Sweden	*	2	0	1	2	0	5	X	X		10
	5	BRA - Brazil		0	1	0	0	1	0	X	X		2
B	6	GER - Germany	*	5	0	4	6	2	4	X	X		21
	6	NGR - Nigeria		0	1	0	0	0	0	X	X		1
C	6	SLO - Slovenia	*	1	0	2	0	1	2	0	0		6
	6	SCO - Scotland		0	2	0	3	0	0	2	1		8
D	6	AUT - Austria		0	1	0	0	1	0	X	X		2
	6	KOR - Korea	*	0	0	3	3	0	3	X	X		9
E	6	BLR - Belarus	*	0	0	2	1	0	1	0	0		4
	6	SVK - Slovakia		1	0	0	0	2	0	0	2		5
F	6	KAZ - Kazakhstan	*	0	1	0	2	0	0	3	0		6
	6	USA - United States		2	0	1	0	0	2	0	2		7

Current Standings

Group A					Group B				
Rank	Team	Games	Wins	Losses	Rank	Team	Games	Wins	Losses
1	CAN - Canada	5	5	0	1	CZE - Czech Republic	6	5	1
2	GER - Germany	6	5	1	1	DEN - Denmark	6	5	1
3	SVK - Slovakia	6	4	2	1	NOR - Norway	6	5	1
4	BLR - Belarus	6	3	3	4	POL - Poland	6	4	2
5	EST - Estonia	5	2	3	5	WAL - Wales	6	3	3
5	HKG - Hong Kong	5	2	3	6	CRO - Croatia	6	1	5
7	KOS - Kosovo	5	1	4	6	NZL - New Zealand	6	1	5
8	NGR - Nigeria	6	0	6	8	AND - Andorra	6	0	6
Group C					Group D				
Rank	Team	Games	Wins	Losses	Rank	Team	Games	Wins	Losses
1	ESP - Spain	5	5	0	1	SCO - Scotland	6	6	0
2	HUN - Hungary	6	5	1	2	IRL - Ireland	6	5	1
2	USA - United States	6	5	1	3	ITA - Italy	6	4	2
4	KAZ - Kazakhstan	6	3	3	4	JPN - Japan	6	3	3
4	SWE - Sweden	6	3	3	4	TUR - Turkey	6	3	3
6	AUS - Australia	6	2	4	6	SLO - Slovenia	6	2	4
7	BRA - Brazil	5	0	5	7	TPE - Chinese Taipei	6	1	5
8	LAT - Latvia	6	0	6	8	LUX - Luxembourg	6	0	6
Group E									
Rank	Team	Games	Wins	Losses					
1	RUS - Russia	6	6	0					
2	SUI - Switzerland	6	5	1					
3	KOR - Korea	6	4	2					
4	ENG - England	6	3	3					
4	FIN - Finland	6	3	3					
6	FRA - France	6	2	4					
7	AUT - Austria	6	1	5					
8	BEL - Belgium	6	0	6					

Note:
Under WCF rules, tie-breaking rules for standings are not applied until after the last game of the round robin.

Legend:
LSFE(*) Last Stone First End **Q** Qualified for the play-offs **X** Unplayed/unfinished end due to concession



WED 16 OCT 2019
Start Time 16:00

Round Robin Session 19

Session Results and Standings

Sheet	Game	Team	LSFE	1	2	3	4	5	6	7	8	Extra Ends	Total
A	5	ESP - Spain		0	2	3	0	3	0	1	X		9
	6	LAT - Latvia	*	0	0	0	2	0	1	0	X		3
B	6	RUS - Russia	*	2	0	1	0	4	0	0	X		7
	6	FIN - Finland		0	2	0	1	0	1	1	X		5
C	6	BEL - Belgium		0	0	0	0	0	1	X	X		1
	6	ENG - England	*	3	2	4	2	2	0	X	X		13
D	6	LUX - Luxembourg		0	0	1	0	0	1	X	X		2
	6	IRL - Ireland	*	3	1	0	4	2	0	X	X		10
E	6	TUR - Turkey		0	0	0	0	1	0	1	X		2
	6	JPN - Japan	*	0	0	1	2	0	2	0	X		5
F	6	HUN - Hungary		0	1	1	1	0	1	1	1		6
	6	AUS - Australia	*	4	0	0	0	1	0	0	0		5

Current Standings

Group A					Group B					
Rank	Team	Games	Wins	Losses	Rank	Team	Games	Wins	Losses	
1	CAN - Canada	5	5	0	Q	1	CZE - Czech Republic	6	5	1
2	GER - Germany	5	4	1		1	DEN - Denmark	6	5	1
3	BLR - Belarus	5	3	2		1	NOR - Norway	6	5	1
3	SVK - Slovakia	5	3	2		4	POL - Poland	6	4	2
5	EST - Estonia	5	2	3		5	WAL - Wales	6	3	3
5	HKG - Hong Kong	5	2	3		6	CRO - Croatia	6	1	5
7	KOS - Kosovo	5	1	4		6	NZL - New Zealand	6	1	5
8	NGR - Nigeria	5	0	5		8	AND - Andorra	6	0	6
Group C					Group D					
Rank	Team	Games	Wins	Losses	Rank	Team	Games	Wins	Losses	
1	ESP - Spain	5	5	0	Q	1	SCO - Scotland	5	5	0
2	HUN - Hungary	6	5	1		2	IRL - Ireland	6	5	1
3	USA - United States	5	4	1		3	ITA - Italy	6	4	2
4	KAZ - Kazakhstan	5	3	2		4	JPN - Japan	6	3	3
5	SWE - Sweden	5	2	3		4	TUR - Turkey	6	3	3
6	AUS - Australia	6	2	4		6	SLO - Slovenia	5	2	3
7	BRA - Brazil	4	0	4		7	TPE - Chinese Taipei	6	1	5
8	LAT - Latvia	6	0	6		8	LUX - Luxembourg	6	0	6
Group E										
Rank	Team	Games	Wins	Losses						
1	RUS - Russia	6	6	0	Q					
2	SUI - Switzerland	6	5	1	Q					
3	KOR - Korea	5	3	2						
4	ENG - England	6	3	3						
4	FIN - Finland	6	3	3						
6	FRA - France	6	2	4						
7	AUT - Austria	5	1	4						
8	BEL - Belgium	6	0	6						

Note:
Under WCF rules, tie-breaking rules for standings are not applied until after the last game of the round robin.

Legend:
LSFE(*) Last Stone First End **Q** Qualified for the play-offs **X** Unplayed/unfinished end due to concession





WED 16 OCT 2019
Start Time 12:00

Round Robin Session 18

Session Results and Standings

Sheet	Game	Team	LSFE	1	2	3	4	5	6	7	8	Extra Ends	Total
A	6	SUI - Switzerland		2	0	1	1	3	0	X	X		7
	5	AUT - Austria	*	0	1	0	0	0	1	X	X		2
B	5	HKG - Hong Kong		0	3	0	1	0	0	0	1		5
	5	SVK - Slovakia	*	2	0	2	0	0	1	1	0		6
C	5	GER - Germany	*	1	2	0	1	0	0	2	0		6
	5	EST - Estonia		0	0	1	0	1	1	0	1		4
D	5	BLR - Belarus	*	1	2	2	3	0	3	X	X		11
	5	KOS - Kosovo		0	0	0	0	1	0	X	X		1
E	5	CAN - Canada	*	4	1	1	2	4	0	3	X		15
	5	NGR - Nigeria		0	0	0	0	0	1	0	X		1
F	6	TPE - Chinese Taipei	*	1	0	0	0	0	2	0	X		3
	5	SLO - Slovenia		0	1	1	1	2	0	1	X		6

Current Standings

Group A					Group B				
Rank	Team	Games	Wins	Losses	Rank	Team	Games	Wins	Losses
1	CAN - Canada	5	5	0	1	CZE - Czech Republic	6	5	1
2	GER - Germany	5	4	1	1	DEN - Denmark	6	5	1
3	BLR - Belarus	5	3	2	1	NOR - Norway	6	5	1
3	SVK - Slovakia	5	3	2	4	POL - Poland	6	4	2
5	EST - Estonia	5	2	3	5	WAL - Wales	6	3	3
5	HKG - Hong Kong	5	2	3	6	CRO - Croatia	6	1	5
7	KOS - Kosovo	5	1	4	6	NZL - New Zealand	6	1	5
8	NGR - Nigeria	5	0	5	8	AND - Andorra	6	0	6
Group C					Group D				
Rank	Team	Games	Wins	Losses	Rank	Team	Games	Wins	Losses
1	ESP - Spain	4	4	0	1	SCO - Scotland	5	5	0
2	HUN - Hungary	5	4	1	2	IRL - Ireland	5	4	1
2	USA - United States	5	4	1	3	ITA - Italy	6	4	2
4	KAZ - Kazakhstan	5	3	2	4	TUR - Turkey	5	3	2
5	AUS - Australia	5	2	3	5	JPN - Japan	5	2	3
5	SWE - Sweden	5	2	3	5	SLO - Slovenia	5	2	3
7	BRA - Brazil	4	0	4	7	TPE - Chinese Taipei	6	1	5
8	LAT - Latvia	5	0	5	8	LUX - Luxembourg	5	0	5
Group E									
Rank	Team	Games	Wins	Losses					
1	RUS - Russia	5	5	0					
2	SUI - Switzerland	6	5	1					
3	FIN - Finland	5	3	2					
3	KOR - Korea	5	3	2					
5	ENG - England	5	2	3					
6	FRA - France	6	2	4					
7	AUT - Austria	5	1	4					
8	BEL - Belgium	5	0	5					

Note:
Under WCF rules, tie-breaking rules for standings are not applied until after the last game of the round robin.

Legend:
LSFE(*) Last Stone First End **Q** Qualified for the play-offs **X** Unplayed/unfinished end due to concession



WED 16 OCT 2019
Start Time 8:00

Round Robin Session 17

Session Results and Standings

Sheet	Game	Team	LSFE	1	2	3	4	5	6	7	8	Extra Ends	Total
A	6	FRA - France	*	2	1	0	4	2	1	X	X		10
	5	BEL - Belgium		0	0	2	0	0	0	X	X		2
B	6	POL - Poland	*	3	3	1	3	0	2	X	X		12
	6	NZL - New Zealand		0	0	0	0	1	0	X	X		1
C	6	CZE - Czech Republic	*	2	0	2	0	2	0	2	X		8
	6	WAL - Wales		0	1	0	1	0	1	0	X		3
D	6	CRO - Croatia		0	1	0	2	0	0	X	X		3
	6	DEN - Denmark	*	4	0	2	0	2	4	X	X		12
E	6	NOR - Norway		1	2	3	1	3	5	X	X		15
	6	AND - Andorra	*	0	0	0	0	0	0	X	X		0
F	6	ITA - Italy	*	5	0	3	2	2	2	X	X		14
	5	LUX - Luxembourg		0	1	0	0	0	0	X	X		1

Current Standings

Group A					Group B				
Rank	Team	Games	Wins	Losses	Rank	Team	Games	Wins	Losses
1	CAN - Canada	4	4	0	1	CZE - Czech Republic	6	5	1
2	GER - Germany	4	3	1	1	DEN - Denmark	6	5	1
3	BLR - Belarus	4	2	2	1	NOR - Norway	6	5	1
3	EST - Estonia	4	2	2	4	POL - Poland	6	4	2
3	HKG - Hong Kong	4	2	2	5	WAL - Wales	6	3	3
3	SVK - Slovakia	4	2	2	6	CRO - Croatia	6	1	5
7	KOS - Kosovo	4	1	3	6	NZL - New Zealand	6	1	5
8	NGR - Nigeria	4	0	4	8	AND - Andorra	6	0	6
Group C					Group D				
Rank	Team	Games	Wins	Losses	Rank	Team	Games	Wins	Losses
1	ESP - Spain	4	4	0	1	SCO - Scotland	5	5	0
2	HUN - Hungary	5	4	1	2	IRL - Ireland	5	4	1
2	USA - United States	5	4	1	3	ITA - Italy	6	4	2
4	KAZ - Kazakhstan	5	3	2	4	TUR - Turkey	5	3	2
5	AUS - Australia	5	2	3	5	JPN - Japan	5	2	3
5	SWE - Sweden	5	2	3	6	SLO - Slovenia	4	1	3
7	BRA - Brazil	4	0	4	7	TPE - Chinese Taipei	5	1	4
8	LAT - Latvia	5	0	5	8	LUX - Luxembourg	5	0	5
Group E									
Rank	Team	Games	Wins	Losses					
1	RUS - Russia	5	5	0					
2	SUI - Switzerland	5	4	1					
3	FIN - Finland	5	3	2					
3	KOR - Korea	5	3	2					
5	ENG - England	5	2	3					
6	FRA - France	6	2	4					
7	AUT - Austria	4	1	3					
8	BEL - Belgium	5	0	5					

Note:
Under WCF rules, tie-breaking rules for standings are not applied until after the last game of the round robin.

Legend:
LSFE(*) Last Stone First End X Unplayed/unfinished end due to concession



TUE 15 OCT 2019
Start Time 20:00

Round Robin Session 16

Session Results and Standings

Sheet	Game	Team	LSFE	1	2	3	4	5	6	7	8	Extra Ends	Total
A	4	HKG - Hong Kong	*	3	0	1	1	0	1	0	0		6
	4	CAN - Canada		0	2	0	0	3	0	2	1		8
B	4	EST - Estonia		4	0	0	0	0	0	1	1		6
	4	BLR - Belarus	*	0	2	1	4	0	1	0	0		8
C	5	KAZ - Kazakhstan		0	0	1	1	0	1	1	X		4
	4	ESP - Spain	*	2	1	0	0	4	0	0	X		7
D	4	BRA - Brazil		0	0	0	0	0	1	0	X		1
	5	AUS - Australia	*	1	1	2	2	2	0	2	X		10
E	4	KOS - Kosovo		0	0	0	0	0	1	X	X		1
	4	GER - Germany	*	4	3	2	4	1	0	X	X		14
F	4	NGR - Nigeria	*	0	0	0	0	0	0	0	X		0
	4	SVK - Slovakia		2	3	2	1	4	1	1	X		14

Current Standings

Group A					Group B				
Rank	Team	Games	Wins	Losses	Rank	Team	Games	Wins	Losses
1	CAN - Canada	4	4	0	1	CZE - Czech Republic	5	4	1
2	GER - Germany	4	3	1	1	DEN - Denmark	5	4	1
3	BLR - Belarus	4	2	2	1	NOR - Norway	5	4	1
3	EST - Estonia	4	2	2	4	POL - Poland	5	3	2
3	HKG - Hong Kong	4	2	2	4	WAL - Wales	5	3	2
3	SVK - Slovakia	4	2	2	6	CRO - Croatia	5	1	4
7	KOS - Kosovo	4	1	3	6	NZL - New Zealand	5	1	4
8	NGR - Nigeria	4	0	4	8	AND - Andorra	5	0	5
Group C					Group D				
Rank	Team	Games	Wins	Losses	Rank	Team	Games	Wins	Losses
1	ESP - Spain	4	4	0	1	SCO - Scotland	5	5	0
2	HUN - Hungary	5	4	1	2	IRL - Ireland	5	4	1
2	USA - United States	5	4	1	3	ITA - Italy	5	3	2
4	KAZ - Kazakhstan	5	3	2	3	TUR - Turkey	5	3	2
5	AUS - Australia	5	2	3	5	JPN - Japan	5	2	3
5	SWE - Sweden	5	2	3	6	SLO - Slovenia	4	1	3
7	BRA - Brazil	4	0	4	7	TPE - Chinese Taipei	5	1	4
8	LAT - Latvia	5	0	5	8	LUX - Luxembourg	4	0	4
Group E									
Rank	Team	Games	Wins	Losses					
1	RUS - Russia	5	5	0					
2	SUI - Switzerland	5	4	1					
3	FIN - Finland	5	3	2					
3	KOR - Korea	5	3	2					
5	ENG - England	5	2	3					
6	AUT - Austria	4	1	3					
7	FRA - France	5	1	4					
8	BEL - Belgium	4	0	4					

Note:
Under WCF rules, tie-breaking rules for standings are not applied until after the last game of the round robin.

Legend:
LSFE(*) Last Stone First End X Unplayed/unfinished end due to concession



TUE 15 OCT 2019
Start Time 16:00

Round Robin Session 15

Session Results and Standings

Sheet	Game	Team	LSFE	1	2	3	4	5	6	7	8	Extra Ends	Total
A	5	TPE - Chinese Taipei		0	0	0	0	1	0	X	X		1
	5	JPN - Japan	*	6	1	1	1	0	1	X	X		10
B	5	FRA - France	*	1	2	0	1	2	0	1	X		7
	4	AUT - Austria		0	0	1	0	0	3	0	X		4
C	5	TUR - Turkey	*	0	2	0	5	0	0	3	X		10
	4	LUX - Luxembourg		1	0	1	0	1	0	0	X		3
D	5	RUS - Russia	*	1	0	1	2	0	6	X	X		10
	4	BEL - Belgium		0	1	0	0	2	0	X	X		3
E	5	ITA - Italy	*	3	0	1	2	0	1	0	X		7
	4	SLO - Slovenia		0	1	0	0	3	0	1	X		5
F	5	SUI - Switzerland	*	0	2	0	2	0	0	4	1		9
	5	FIN - Finland		0	0	2	0	0	3	0	0		5

Current Standings

Group A					Group B				
Rank	Team	Games	Wins	Losses	Rank	Team	Games	Wins	Losses
1	CAN - Canada	3	3	0	1	CZE - Czech Republic	5	4	1
2	EST - Estonia	3	2	1	1	DEN - Denmark	5	4	1
2	GER - Germany	3	2	1	1	NOR - Norway	5	4	1
2	HKG - Hong Kong	3	2	1	4	POL - Poland	5	3	2
5	BLR - Belarus	3	1	2	4	WAL - Wales	5	3	2
5	KOS - Kosovo	3	1	2	6	CRO - Croatia	5	1	4
5	SVK - Slovakia	3	1	2	6	NZL - New Zealand	5	1	4
8	NGR - Nigeria	3	0	3	8	AND - Andorra	5	0	5
Group C					Group D				
Rank	Team	Games	Wins	Losses	Rank	Team	Games	Wins	Losses
1	HUN - Hungary	5	4	1	1	SCO - Scotland	5	5	0
1	USA - United States	5	4	1	2	IRL - Ireland	5	4	1
3	ESP - Spain	3	3	0	3	ITA - Italy	5	3	2
4	KAZ - Kazakhstan	4	3	1	3	TUR - Turkey	5	3	2
5	SWE - Sweden	5	2	3	5	JPN - Japan	5	2	3
6	AUS - Australia	4	1	3	6	SLO - Slovenia	4	1	3
7	BRA - Brazil	3	0	3	7	TPE - Chinese Taipei	5	1	4
8	LAT - Latvia	5	0	5	8	LUX - Luxembourg	4	0	4
Group E									
Rank	Team	Games	Wins	Losses					
1	RUS - Russia	5	5	0					
2	SUI - Switzerland	5	4	1					
3	FIN - Finland	5	3	2					
3	KOR - Korea	5	3	2					
5	ENG - England	5	2	3					
6	AUT - Austria	4	1	3					
7	FRA - France	5	1	4					
8	BEL - Belgium	4	0	4					

Note:
Under WCF rules, tie-breaking rules for standings are not applied until after the last game of the round robin.

Legend:
LSFE(*) Last Stone First End X Unplayed/unfinished end due to concession

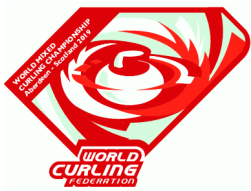

TUE 15 OCT 2019
Start Time 12:00

Round Robin Session 14

Session Results and Standings

Sheet	Game	Team	LSFE	1	2	3	4	5	6	7	8	Extra Ends	Total
A	5	CRO - Croatia		0	0	0	2	0	0	X	X		2
	5	CZE - Czech Republic	*	5	1	2	0	1	3	X	X		12
B	5	USA - United States		0	2	0	4	0	2	X	X		8
	5	SWE - Sweden	*	1	0	1	0	1	0	X	X		3
C	5	NZL - New Zealand	*	1	0	0	1	0	1	0	X		3
	5	DEN - Denmark		0	2	1	0	2	0	1	X		6
D	5	WAL - Wales	*	0	0	4	0	2	1	0	X		7
	5	AND - Andorra		1	1	0	1	0	0	2	X		5
E	5	LAT - Latvia		1	0	0	1	0	1	0	X		3
	5	HUN - Hungary	*	0	1	1	0	3	0	2	X		7
F	5	NOR - Norway	*	1	0	2	0	2	1	0	X		6
	5	POL - Poland		0	1	0	1	0	0	2	X		4

Current Standings

Group A					Group B				
Rank	Team	Games	Wins	Losses	Rank	Team	Games	Wins	Losses
1	CAN - Canada	3	3	0	1	CZE - Czech Republic	5	4	1
2	EST - Estonia	3	2	1	1	DEN - Denmark	5	4	1
2	GER - Germany	3	2	1	1	NOR - Norway	5	4	1
2	HKG - Hong Kong	3	2	1	4	POL - Poland	5	3	2
5	BLR - Belarus	3	1	2	4	WAL - Wales	5	3	2
5	KOS - Kosovo	3	1	2	6	CRO - Croatia	5	1	4
5	SVK - Slovakia	3	1	2	6	NZL - New Zealand	5	1	4
8	NGR - Nigeria	3	0	3	8	AND - Andorra	5	0	5
Group C					Group D				
Rank	Team	Games	Wins	Losses	Rank	Team	Games	Wins	Losses
1	HUN - Hungary	5	4	1	1	SCO - Scotland	5	5	0
1	USA - United States	5	4	1	2	IRL - Ireland	5	4	1
3	ESP - Spain	3	3	0	3	ITA - Italy	4	2	2
4	KAZ - Kazakhstan	4	3	1	3	TUR - Turkey	4	2	2
5	SWE - Sweden	5	2	3	5	SLO - Slovenia	3	1	2
6	AUS - Australia	4	1	3	6	JPN - Japan	4	1	3
7	BRA - Brazil	3	0	3	6	TPE - Chinese Taipei	4	1	3
8	LAT - Latvia	5	0	5	8	LUX - Luxembourg	3	0	3
Group E									
Rank	Team	Games	Wins	Losses					
1	RUS - Russia	4	4	0					
2	FIN - Finland	4	3	1					
2	SUI - Switzerland	4	3	1					
4	KOR - Korea	5	3	2					
5	ENG - England	5	2	3					
6	AUT - Austria	3	1	2					
7	BEL - Belgium	3	0	3					
8	FRA - France	4	0	4					

Note:
Under WCF rules, tie-breaking rules for standings are not applied until after the last game of the round robin.

Legend:
LSFE(*) Last Stone First End X Unplayed/unfinished end due to concession



TUE 15 OCT 2019
Start Time 8:00

Round Robin Session 13

Session Results and Standings

Sheet	Game	Team	LSFE	1	2	3	4	5	6	7	8	Extra Ends	Total
A	5	ENG - England		2	0	0	0	1	0	0	X		3
	4	RUS - Russia	*	0	2	1	1	0	3	2	X		9
C	5	KOR - Korea	*	0	2	0	0	0	1	0	X		3
	4	SUI - Switzerland		0	0	0	3	1	0	1	X		5
D	5	SCO - Scotland	*	1	0	3	3	0	4	X	X		11
	4	TPE - Chinese Taipei		0	3	0	0	1	0	X	X		4
F	5	IRL - Ireland		0	1	0	0	0	2	0	0		3
	4	TUR - Turkey	*	1	0	1	1	1	0	0	1		5

Current Standings

Group A					Group B				
Rank	Team	Games	Wins	Losses	Rank	Team	Games	Wins	Losses
1	CAN - Canada	3	3	0	1	CZE - Czech Republic	4	3	1
2	EST - Estonia	3	2	1	1	DEN - Denmark	4	3	1
2	GER - Germany	3	2	1	1	NOR - Norway	4	3	1
2	HKG - Hong Kong	3	2	1	1	POL - Poland	4	3	1
5	BLR - Belarus	3	1	2	5	WAL - Wales	4	2	2
5	KOS - Kosovo	3	1	2	6	CRO - Croatia	4	1	3
5	SVK - Slovakia	3	1	2	6	NZL - New Zealand	4	1	3
8	NGR - Nigeria	3	0	3	8	AND - Andorra	4	0	4
Group C					Group D				
Rank	Team	Games	Wins	Losses	Rank	Team	Games	Wins	Losses
1	ESP - Spain	3	3	0	1	SCO - Scotland	5	5	0
2	HUN - Hungary	4	3	1	2	IRL - Ireland	5	4	1
2	KAZ - Kazakhstan	4	3	1	3	ITA - Italy	4	2	2
2	USA - United States	4	3	1	3	TUR - Turkey	4	2	2
5	SWE - Sweden	4	2	2	5	SLO - Slovenia	3	1	2
6	AUS - Australia	4	1	3	6	JPN - Japan	4	1	3
7	BRA - Brazil	3	0	3	6	TPE - Chinese Taipei	4	1	3
8	LAT - Latvia	4	0	4	8	LUX - Luxembourg	3	0	3
Group E									
Rank	Team	Games	Wins	Losses					
1	RUS - Russia	4	4	0					
2	FIN - Finland	4	3	1					
2	SUI - Switzerland	4	3	1					
4	KOR - Korea	5	3	2					
5	ENG - England	5	2	3					
6	AUT - Austria	3	1	2					
7	BEL - Belgium	3	0	3					
8	FRA - France	4	0	4					

Note:
Under WCF rules, tie-breaking rules for standings are not applied until after the last game of the round robin.

Legend:
LSFE(*) Last Stone First End X Unplayed/unfinished end due to concession



MON 14 OCT 2019
Start Time 20:00

Round Robin Session 12

Session Results and Standings

Sheet	Game	Team	LSFE	1	2	3	4	5	6	7	8	Extra Ends	Total
A	4	HUN - Hungary	*	2	1	0	0	1	0	0	X		4
	4	USA - United States		0	0	3	1	0	2	1	X		7
B	4	AUS - Australia	*	1	0	0	0	0	1	X	X		2
	3	ESP - Spain		0	2	0	2	3	0	X	X		7
C	4	NOR - Norway	*	3	4	2	4	2	1	X	X		16
	4	CRO - Croatia		0	0	0	0	0	0	X	X		0
D	4	POL - Poland	*	2	1	0	2	0	0	1	X		6
	4	CZE - Czech Republic		0	0	1	0	0	2	0	X		3
E	4	NZL - New Zealand	*	0	0	0	0	0	2	0	2	0	4
	4	WAL - Wales		1	0	1	0	0	0	2	0	1	5
F	4	SWE - Sweden	*	2	3	1	1	0	1	1	X		9
	4	LAT - Latvia		0	0	0	0	2	0	0	X		2

Current Standings

Group A					Group B				
Rank	Team	Games	Wins	Losses	Rank	Team	Games	Wins	Losses
1	CAN - Canada	3	3	0	1	CZE - Czech Republic	4	3	1
2	EST - Estonia	3	2	1	1	DEN - Denmark	4	3	1
2	GER - Germany	3	2	1	1	NOR - Norway	4	3	1
2	HKG - Hong Kong	3	2	1	1	POL - Poland	4	3	1
5	BLR - Belarus	3	1	2	5	WAL - Wales	4	2	2
5	KOS - Kosovo	3	1	2	6	CRO - Croatia	4	1	3
5	SVK - Slovakia	3	1	2	6	NZL - New Zealand	4	1	3
8	NGR - Nigeria	3	0	3	8	AND - Andorra	4	0	4
Group C					Group D				
Rank	Team	Games	Wins	Losses	Rank	Team	Games	Wins	Losses
1	ESP - Spain	3	3	0	1	IRL - Ireland	4	4	0
2	HUN - Hungary	4	3	1	1	SCO - Scotland	4	4	0
2	KAZ - Kazakhstan	4	3	1	3	ITA - Italy	4	2	2
2	USA - United States	4	3	1	4	SLO - Slovenia	3	1	2
5	SWE - Sweden	4	2	2	4	TPE - Chinese Taipei	3	1	2
6	AUS - Australia	4	1	3	4	TUR - Turkey	3	1	2
7	BRA - Brazil	3	0	3	7	JPN - Japan	4	1	3
8	LAT - Latvia	4	0	4	8	LUX - Luxembourg	3	0	3
Group E									
Rank	Team	Games	Wins	Losses					
1	RUS - Russia	3	3	0					
2	FIN - Finland	4	3	1					
2	KOR - Korea	4	3	1					
4	SUI - Switzerland	3	2	1					
5	ENG - England	4	2	2					
6	AUT - Austria	3	1	2					
7	BEL - Belgium	3	0	3					
8	FRA - France	4	0	4					

Note:
Under WCF rules, tie-breaking rules for standings are not applied until after the last game of the round robin.

Legend:
LSFE(*) Last Stone First End X Unplayed/unfinished end due to concession



MON 14 OCT 2019
Start Time 16:00

Round Robin Session 11

Session Results and Standings

Sheet	Game	Team	LSFE	1	2	3	4	5	6	7	8	Extra Ends	Total
A	3	BLR - Belarus	*	0	0	0	0	0	0	0	X		0
	3	GER - Germany		1	1	0	2	2	1	1	X		8
B	4	DEN - Denmark	*	1	1	1	1	0	2	X	X		6
	4	AND - Andorra		0	0	0	0	1	0	X	X		1
C	3	SVK - Slovakia	*	0	0	1	0	1	0	2	X		4
	3	CAN - Canada		3	0	0	2	0	2	0	X		7
D	3	NGR - Nigeria		0	0	0	0	0	0	X	X		0
	3	HKG - Hong Kong	*	4	1	1	3	1	2	X	X		12
E	3	BRA - Brazil		0	0	0	0	1	1	X	X		2
	4	KAZ - Kazakhstan	*	2	4	2	2	0	0	X	X		10
F	3	EST - Estonia		4	0	2	1	7	1	3	X		18
	3	KOS - Kosovo	*	0	1	0	0	0	0	0	X		1

Current Standings

Group A					Group B				
Rank	Team	Games	Wins	Losses	Rank	Team	Games	Wins	Losses
1	CAN - Canada	3	3	0	1	CZE - Czech Republic	3	3	0
2	EST - Estonia	3	2	1	2	DEN - Denmark	4	3	1
2	GER - Germany	3	2	1	3	NOR - Norway	3	2	1
2	HKG - Hong Kong	3	2	1	3	POL - Poland	3	2	1
5	BLR - Belarus	3	1	2	5	CRO - Croatia	3	1	2
5	KOS - Kosovo	3	1	2	5	NZL - New Zealand	3	1	2
5	SVK - Slovakia	3	1	2	5	WAL - Wales	3	1	2
8	NGR - Nigeria	3	0	3	8	AND - Andorra	4	0	4
Group C					Group D				
Rank	Team	Games	Wins	Losses	Rank	Team	Games	Wins	Losses
1	HUN - Hungary	3	3	0	1	IRL - Ireland	4	4	0
2	KAZ - Kazakhstan	4	3	1	1	SCO - Scotland	4	4	0
3	ESP - Spain	2	2	0	3	ITA - Italy	4	2	2
4	USA - United States	3	2	1	4	SLO - Slovenia	3	1	2
5	AUS - Australia	3	1	2	4	TPE - Chinese Taipei	3	1	2
5	SWE - Sweden	3	1	2	4	TUR - Turkey	3	1	2
7	BRA - Brazil	3	0	3	7	JPN - Japan	4	1	3
7	LAT - Latvia	3	0	3	8	LUX - Luxembourg	3	0	3
Group E									
Rank	Team	Games	Wins	Losses					
1	RUS - Russia	3	3	0					
2	FIN - Finland	4	3	1					
2	KOR - Korea	4	3	1					
4	SUI - Switzerland	3	2	1					
5	ENG - England	4	2	2					
6	AUT - Austria	3	1	2					
7	BEL - Belgium	3	0	3					
8	FRA - France	4	0	4					

Note:
Under WCF rules, tie-breaking rules for standings are not applied until after the last game of the round robin.

Legend:
LSFE(*) Last Stone First End X Unplayed/unfinished end due to concession



MON 14 OCT 2019
Start Time 12:00

Round Robin Session 10

Session Results and Standings

Sheet	Game	Team	LSFE	1	2	3	4	5	6	7	8	Extra Ends	Total
A	4	ITA - Italy	*	0	0	2	0	2	1	5	X		10
	3	TPE - Chinese Taipei		0	1	0	1	0	0	0	X		2
B	4	JPN - Japan	*	1	0	0	2	0	0	0	X		3
	4	IRL - Ireland		0	2	0	0	4	1	2	X		9
C	3	RUS - Russia	*	0	0	3	2	4	1	X	X		10
	4	KOR - Korea		0	2	0	0	0	0	X	X		2
D	3	TUR - Turkey		0	2	0	0	0	1	0	X		3
	4	SCO - Scotland	*	1	0	0	2	1	0	1	X		5
E	4	FIN - Finland		2	1	0	1	1	0	3	X		8
	4	ENG - England	*	0	0	1	0	0	2	0	X		3
F	4	FRA - France		0	0	1	0	1	0	0	0		2
	3	SUI - Switzerland	*	2	0	0	0	0	1	1	2		6

Current Standings

Group A					Group B				
Rank	Team	Games	Wins	Losses	Rank	Team	Games	Wins	Losses
1	CAN - Canada	2	2	0	1	CZE - Czech Republic	3	3	0
2	BLR - Belarus	2	1	1	2	DEN - Denmark	3	2	1
2	EST - Estonia	2	1	1	2	NOR - Norway	3	2	1
2	GER - Germany	2	1	1	2	POL - Poland	3	2	1
2	HKG - Hong Kong	2	1	1	5	CRO - Croatia	3	1	2
2	KOS - Kosovo	2	1	1	5	NZL - New Zealand	3	1	2
2	SVK - Slovakia	2	1	1	5	WAL - Wales	3	1	2
8	NGR - Nigeria	2	0	2	8	AND - Andorra	3	0	3
Group C					Group D				
Rank	Team	Games	Wins	Losses	Rank	Team	Games	Wins	Losses
1	HUN - Hungary	3	3	0	1	IRL - Ireland	4	4	0
2	ESP - Spain	2	2	0	1	SCO - Scotland	4	4	0
3	KAZ - Kazakhstan	3	2	1	3	ITA - Italy	4	2	2
3	USA - United States	3	2	1	4	SLO - Slovenia	3	1	2
5	AUS - Australia	3	1	2	4	TPE - Chinese Taipei	3	1	2
5	SWE - Sweden	3	1	2	4	TUR - Turkey	3	1	2
7	BRA - Brazil	2	0	2	7	JPN - Japan	4	1	3
8	LAT - Latvia	3	0	3	8	LUX - Luxembourg	3	0	3
Group E									
Rank	Team	Games	Wins	Losses					
1	RUS - Russia	3	3	0					
2	FIN - Finland	4	3	1					
2	KOR - Korea	4	3	1					
4	SUI - Switzerland	3	2	1					
5	ENG - England	4	2	2					
6	AUT - Austria	3	1	2					
7	BEL - Belgium	3	0	3					
8	FRA - France	4	0	4					

Note:
Under WCF rules, tie-breaking rules for standings are not applied until after the last game of the round robin.

Legend:
LSFE(*) Last Stone First End X Unplayed/unfinished end due to concession



MON 14 OCT 2019
Start Time 8:00

Round Robin Session 9

Session Results and Standings

Sheet	Game	Team	LSFE	1	2	3	4	5	6	7	8	Extra Ends	Total
A	3	AUS - Australia		0	1	0	0	2	0	3	0		6
	3	KAZ - Kazakhstan	*	0	0	3	1	0	2	0	1		7
B	3	AUT - Austria	*	1	0	1	1	0	1	0	1		5
	3	BEL - Belgium		0	1	0	0	1	0	2	0		4
C	3	HUN - Hungary	*	1	2	0	4	0	1	1	X		9
	3	SWE - Sweden		0	0	2	0	1	0	0	X		3
D	3	USA - United States		0	2	0	0	3	0	2	X		7
	3	LAT - Latvia	*	0	0	1	1	0	1	0	X		3
E	3	SLO - Slovenia	*	1	1	1	0	4	0	4	X		11
	3	LUX - Luxembourg		0	0	0	1	0	1	0	X		2

Current Standings

Group A					Group B				
Rank	Team	Games	Wins	Losses	Rank	Team	Games	Wins	Losses
1	CAN - Canada	2	2	0	1	CZE - Czech Republic	3	3	0
2	BLR - Belarus	2	1	1	2	DEN - Denmark	3	2	1
2	EST - Estonia	2	1	1	2	NOR - Norway	3	2	1
2	GER - Germany	2	1	1	2	POL - Poland	3	2	1
2	HKG - Hong Kong	2	1	1	5	CRO - Croatia	3	1	2
2	KOS - Kosovo	2	1	1	5	NZL - New Zealand	3	1	2
2	SVK - Slovakia	2	1	1	5	WAL - Wales	3	1	2
8	NGR - Nigeria	2	0	2	8	AND - Andorra	3	0	3
Group C					Group D				
Rank	Team	Games	Wins	Losses	Rank	Team	Games	Wins	Losses
1	HUN - Hungary	3	3	0	1	IRL - Ireland	3	3	0
2	ESP - Spain	2	2	0	1	SCO - Scotland	3	3	0
3	KAZ - Kazakhstan	3	2	1	3	TPE - Chinese Taipei	2	1	1
3	USA - United States	3	2	1	3	TUR - Turkey	2	1	1
5	AUS - Australia	3	1	2	5	ITA - Italy	3	1	2
5	SWE - Sweden	3	1	2	5	JPN - Japan	3	1	2
7	BRA - Brazil	2	0	2	5	SLO - Slovenia	3	1	2
8	LAT - Latvia	3	0	3	8	LUX - Luxembourg	3	0	3
Group E									
Rank	Team	Games	Wins	Losses					
1	KOR - Korea	3	3	0					
2	RUS - Russia	2	2	0					
3	ENG - England	3	2	1					
3	FIN - Finland	3	2	1					
5	SUI - Switzerland	2	1	1					
6	AUT - Austria	3	1	2					
7	BEL - Belgium	3	0	3					
7	FRA - France	3	0	3					

Note:
Under WCF rules, tie-breaking rules for standings are not applied until after the last game of the round robin.

Legend:
LSFE(*) Last Stone First End X Unplayed/unfinished end due to concession



SUN 13 OCT 2019
Start Time 20:00

Round Robin Session 8

Session Results and Standings

Sheet	Game	Team	LSFE	1	2	3	4	5	6	7	8	Extra Ends	Total
A	3	AND - Andorra	*	0	0	0	1	0	1	X	X		2
	3	NZL - New Zealand		1	2	4	0	2	0	X	X		9
B	3	CZE - Czech Republic	*	2	0	2	0	1	2	2	X		9
	3	NOR - Norway		0	2	0	2	0	0	0	X		4
C	3	JPN - Japan		0	1	1	0	2	0	0	0		4
	3	ITA - Italy	*	1	0	0	1	0	3	0	2		7
D	3	ENG - England		0	0	1	0	0	0	0	X		1
	2	SUI - Switzerland	*	0	2	0	2	1	1	1	X		7
E	3	POL - Poland	*	4	0	5	1	4	1	X	X		15
	3	CRO - Croatia		0	1	0	0	0	0	X	X		1
F	3	DEN - Denmark	*	2	2	3	0	4	3	X	X		14
	3	WAL - Wales		0	0	0	1	0	0	X	X		1

Current Standings

Group A					Group B				
Rank	Team	Games	Wins	Losses	Rank	Team	Games	Wins	Losses
1	CAN - Canada	2	2	0	1	CZE - Czech Republic	3	3	0
2	BLR - Belarus	2	1	1	2	DEN - Denmark	3	2	1
2	EST - Estonia	2	1	1	2	NOR - Norway	3	2	1
2	GER - Germany	2	1	1	2	POL - Poland	3	2	1
2	HKG - Hong Kong	2	1	1	5	CRO - Croatia	3	1	2
2	KOS - Kosovo	2	1	1	5	NZL - New Zealand	3	1	2
2	SVK - Slovakia	2	1	1	5	WAL - Wales	3	1	2
8	NGR - Nigeria	2	0	2	8	AND - Andorra	3	0	3
Group C					Group D				
Rank	Team	Games	Wins	Losses	Rank	Team	Games	Wins	Losses
1	ESP - Spain	2	2	0	1	IRL - Ireland	3	3	0
1	HUN - Hungary	2	2	0	1	SCO - Scotland	3	3	0
3	AUS - Australia	2	1	1	3	TPE - Chinese Taipei	2	1	1
3	KAZ - Kazakhstan	2	1	1	3	TUR - Turkey	2	1	1
3	SWE - Sweden	2	1	1	5	ITA - Italy	3	1	2
3	USA - United States	2	1	1	5	JPN - Japan	3	1	2
7	BRA - Brazil	2	0	2	7	LUX - Luxembourg	2	0	2
7	LAT - Latvia	2	0	2	7	SLO - Slovenia	2	0	2
Group E									
Rank	Team	Games	Wins	Losses					
1	KOR - Korea	3	3	0					
2	RUS - Russia	2	2	0					
3	ENG - England	3	2	1					
3	FIN - Finland	3	2	1					
5	SUI - Switzerland	2	1	1					
6	AUT - Austria	2	0	2					
6	BEL - Belgium	2	0	2					
8	FRA - France	3	0	3					

Note:
Under WCF rules, tie-breaking rules for standings are not applied until after the last game of the round robin.

Legend:
LSFE(*) Last Stone First End X Unplayed/unfinished end due to concession



SUN 13 OCT 2019
Start Time 16:00

Round Robin Session 7

Session Results and Standings

Sheet	Game	Team	LSFE	1	2	3	4	5	6	7	8	Extra Ends	Total
A	3	SCO - Scotland	*	5	0	1	0	3	3	X	X		12
	2	LUX - Luxembourg		0	1	0	2	0	0	X	X		3
B	2	SLO - Slovenia		0	0	2	0	2	1	0	0		5
	2	TUR - Turkey	*	0	1	0	2	0	0	1	2		6
C	3	IRL - Ireland		0	1	3	1	0	0	0	1		6
	2	TPE - Chinese Taipei	*	1	0	0	0	1	1	1	0		4
D	3	FIN - Finland	*	0	1	1	0	3	5	X	X		10
	3	FRA - France		0	0	0	4	0	0	X	X		4
E	2	AUT - Austria		0	0	0	1	1	0	X	X		2
	2	RUS - Russia	*	4	2	2	0	0	3	X	X		11
F	3	KOR - Korea	*	3	0	0	3	2	0	4	X		12
	2	BEL - Belgium		0	2	0	0	0	1	0	X		3

Current Standings

Group A					Group B				
Rank	Team	Games	Wins	Losses	Rank	Team	Games	Wins	Losses
1	CAN - Canada	2	2	0	1	CZE - Czech Republic	2	2	0
2	BLR - Belarus	2	1	1	1	NOR - Norway	2	2	0
2	EST - Estonia	2	1	1	3	CRO - Croatia	2	1	1
2	GER - Germany	2	1	1	3	DEN - Denmark	2	1	1
2	HKG - Hong Kong	2	1	1	3	POL - Poland	2	1	1
2	KOS - Kosovo	2	1	1	3	WAL - Wales	2	1	1
2	SVK - Slovakia	2	1	1	7	AND - Andorra	2	0	2
8	NGR - Nigeria	2	0	2	7	NZL - New Zealand	2	0	2
Group C					Group D				
Rank	Team	Games	Wins	Losses	Rank	Team	Games	Wins	Losses
1	ESP - Spain	2	2	0	1	IRL - Ireland	3	3	0
1	HUN - Hungary	2	2	0	1	SCO - Scotland	3	3	0
3	AUS - Australia	2	1	1	3	JPN - Japan	2	1	1
3	KAZ - Kazakhstan	2	1	1	3	TPE - Chinese Taipei	2	1	1
3	SWE - Sweden	2	1	1	3	TUR - Turkey	2	1	1
3	USA - United States	2	1	1	6	ITA - Italy	2	0	2
7	BRA - Brazil	2	0	2	6	LUX - Luxembourg	2	0	2
7	LAT - Latvia	2	0	2	6	SLO - Slovenia	2	0	2
Group E									
Rank	Team	Games	Wins	Losses					
1	KOR - Korea	3	3	0					
2	ENG - England	2	2	0					
2	RUS - Russia	2	2	0					
4	FIN - Finland	3	2	1					
5	SUI - Switzerland	1	0	1					
6	AUT - Austria	2	0	2					
6	BEL - Belgium	2	0	2					
8	FRA - France	3	0	3					

Note:
Under WCF rules, tie-breaking rules for standings are not applied until after the last game of the round robin.

Legend:
LSFE(*) Last Stone First End X Unplayed/unfinished end due to concession



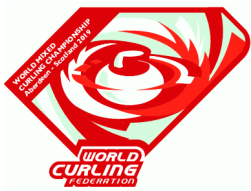

SUN 13 OCT 2019
Start Time 12:00

Round Robin Session 6

Session Results and Standings

Sheet	Game	Team	LSFE	1	2	3	4	5	6	7	8	Extra Ends	Total
A	2	KOS - Kosovo	*	2	1	1	0	2	2	1	X		9
	2	NGR - Nigeria		0	0	0	3	0	0	0	X		3
B	2	HUN - Hungary		0	3	3	0	2	0	1	X		9
	2	KAZ - Kazakhstan	*	1	0	0	1	0	2	0	X		4
C	2	LAT - Latvia		0	1	0	4	0	0	0	0		5
	2	AUS - Australia	*	0	0	1	0	1	1	1	3		7
D	2	SVK - Slovakia		0	1	0	0	2	0	X	X		3
	2	GER - Germany	*	2	0	0	5	0	3	X	X		10
E	2	HKG - Hong Kong	*	1	1	0	0	2	1	1	0		6
	2	EST - Estonia		0	0	1	1	0	0	0	2		4
F	2	CAN - Canada	*	1	1	1	1	0	1	0	X		5
	2	BLR - Belarus		0	0	0	0	1	0	1	X		2

Current Standings

Group A					Group B				
Rank	Team	Games	Wins	Losses	Rank	Team	Games	Wins	Losses
1	CAN - Canada	2	2	0	1	CZE - Czech Republic	2	2	0
2	BLR - Belarus	2	1	1	1	NOR - Norway	2	2	0
2	EST - Estonia	2	1	1	3	CRO - Croatia	2	1	1
2	GER - Germany	2	1	1	3	DEN - Denmark	2	1	1
2	HKG - Hong Kong	2	1	1	3	POL - Poland	2	1	1
2	KOS - Kosovo	2	1	1	3	WAL - Wales	2	1	1
2	SVK - Slovakia	2	1	1	7	AND - Andorra	2	0	2
8	NGR - Nigeria	2	0	2	7	NZL - New Zealand	2	0	2
Group C					Group D				
Rank	Team	Games	Wins	Losses	Rank	Team	Games	Wins	Losses
1	ESP - Spain	2	2	0	1	IRL - Ireland	2	2	0
1	HUN - Hungary	2	2	0	1	SCO - Scotland	2	2	0
3	AUS - Australia	2	1	1	3	TPE - Chinese Taipei	1	1	0
3	KAZ - Kazakhstan	2	1	1	4	JPN - Japan	2	1	1
3	SWE - Sweden	2	1	1	5	LUX - Luxembourg	1	0	1
3	USA - United States	2	1	1	5	SLO - Slovenia	1	0	1
7	BRA - Brazil	2	0	2	5	TUR - Turkey	1	0	1
7	LAT - Latvia	2	0	2	8	ITA - Italy	2	0	2
Group E									
Rank	Team	Games	Wins	Losses					
1	ENG - England	2	2	0					
1	KOR - Korea	2	2	0					
3	RUS - Russia	1	1	0					
4	FIN - Finland	2	1	1					
5	AUT - Austria	1	0	1					
5	BEL - Belgium	1	0	1					
5	SUI - Switzerland	1	0	1					
8	FRA - France	2	0	2					

Note:
Under WCF rules, tie-breaking rules for standings are not applied until after the last game of the round robin.

Legend:
LSFE(*) Last Stone First End X Unplayed/unfinished end due to concession



SUN 13 OCT 2019
Start Time 8:00

Round Robin Session 5

Session Results and Standings

Sheet	Game	Team	LSFE	1	2	3	4	5	6	7	8	Extra Ends	Total
A	2	POL - Poland		0	0	1	1	0	3	0	0		5
	2	DEN - Denmark	*	2	2	0	0	1	0	2	1		8
B	2	CRO - Croatia		0	0	1	0	5	0	0	X		6
	2	WAL - Wales	*	2	1	0	2	0	1	2	X		8
C	2	USA - United States		2	2	4	2	0	2	X	X		12
	2	BRA - Brazil	*	0	0	0	0	2	0	X	X		2
D	2	NOR - Norway	*	2	1	2	0	3	1	1	X		10
	2	NZL - New Zealand		0	0	0	5	0	0	0	X		5
E	2	SWE - Sweden	*	0	0	0	1	0	2	0	X		3
	2	ESP - Spain		0	0	1	0	2	0	2	X		5
F	2	CZE - Czech Republic	*	3	0	2	1	4	1	X	X		11
	2	AND - Andorra		0	1	0	0	0	0	X	X		1

Current Standings

Group A					Group B				
Rank	Team	Games	Wins	Losses	Rank	Team	Games	Wins	Losses
1	BLR - Belarus	1	1	0	1	CZE - Czech Republic	2	2	0
1	CAN - Canada	1	1	0	1	NOR - Norway	2	2	0
1	EST - Estonia	1	1	0	3	CRO - Croatia	2	1	1
1	SVK - Slovakia	1	1	0	3	DEN - Denmark	2	1	1
5	GER - Germany	1	0	1	3	POL - Poland	2	1	1
5	HKG - Hong Kong	1	0	1	3	WAL - Wales	2	1	1
5	KOS - Kosovo	1	0	1	7	AND - Andorra	2	0	2
5	NGR - Nigeria	1	0	1	7	NZL - New Zealand	2	0	2
Group C					Group D				
Rank	Team	Games	Wins	Losses	Rank	Team	Games	Wins	Losses
1	ESP - Spain	2	2	0	1	IRL - Ireland	2	2	0
2	HUN - Hungary	1	1	0	1	SCO - Scotland	2	2	0
2	KAZ - Kazakhstan	1	1	0	3	TPE - Chinese Taipei	1	1	0
4	SWE - Sweden	2	1	1	4	JPN - Japan	2	1	1
4	USA - United States	2	1	1	5	LUX - Luxembourg	1	0	1
6	AUS - Australia	1	0	1	5	SLO - Slovenia	1	0	1
6	LAT - Latvia	1	0	1	5	TUR - Turkey	1	0	1
8	BRA - Brazil	2	0	2	8	ITA - Italy	2	0	2
Group E									
Rank	Team	Games	Wins	Losses					
1	ENG - England	2	2	0					
1	KOR - Korea	2	2	0					
3	RUS - Russia	1	1	0					
4	FIN - Finland	2	1	1					
5	AUT - Austria	1	0	1					
5	BEL - Belgium	1	0	1					
5	SUI - Switzerland	1	0	1					
8	FRA - France	2	0	2					

Note:
Under WCF rules, tie-breaking rules for standings are not applied until after the last game of the round robin.

Legend:
LSFE(*) Last Stone First End X Unplayed/unfinished end due to concession



SAT 12 OCT 2019
Start Time 20:30

Round Robin Session 4

Session Results and Standings

Sheet	Game	Team	LSFE	1	2	3	4	5	6	7	8	Extra Ends	Total
A	2	KOR - Korea		0	1	1	1	0	1	0	2	1	7
	2	FIN - Finland	*	2	0	0	0	2	0	2	0	0	6
B	1	SUI - Switzerland		0	0	1	1	0	1	0	X		3
	1	RUS - Russia	*	0	2	0	0	3	0	1	X		6
C	2	ENG - England	*	1	0	0	1	0	2	0	1		5
	2	FRA - France		0	1	1	0	1	0	1	0		4
D	2	IRL - Ireland	*	1	1	0	2	0	2	0	1		7
	2	ITA - Italy		0	0	1	0	4	0	1	0		6
E	1	TPE - Chinese Taipei	*	3	1	2	0	0	0	0	1	2	9
	1	TUR - Turkey		0	0	0	1	3	1	2	0	0	7
F	2	SCO - Scotland	*	0	1	0	2	0	0	2	0		5
	2	JPN - Japan		1	0	1	0	1	1	0	0		4

Current Standings

Group A					Group B				
Rank	Team	Games	Wins	Losses	Rank	Team	Games	Wins	Losses
1	BLR - Belarus	1	1	0	1	CRO - Croatia	1	1	0
1	CAN - Canada	1	1	0	1	CZE - Czech Republic	1	1	0
1	EST - Estonia	1	1	0	1	NOR - Norway	1	1	0
1	SVK - Slovakia	1	1	0	1	POL - Poland	1	1	0
5	GER - Germany	1	0	1	5	AND - Andorra	1	0	1
5	HKG - Hong Kong	1	0	1	5	DEN - Denmark	1	0	1
5	KOS - Kosovo	1	0	1	5	NZL - New Zealand	1	0	1
5	NGR - Nigeria	1	0	1	5	WAL - Wales	1	0	1
Group C					Group D				
Rank	Team	Games	Wins	Losses	Rank	Team	Games	Wins	Losses
1	ESP - Spain	1	1	0	1	IRL - Ireland	2	2	0
1	HUN - Hungary	1	1	0	1	SCO - Scotland	2	2	0
1	KAZ - Kazakhstan	1	1	0	3	TPE - Chinese Taipei	1	1	0
1	SWE - Sweden	1	1	0	4	JPN - Japan	2	1	1
5	AUS - Australia	1	0	1	5	LUX - Luxembourg	1	0	1
5	BRA - Brazil	1	0	1	5	SLO - Slovenia	1	0	1
5	LAT - Latvia	1	0	1	5	TUR - Turkey	1	0	1
5	USA - United States	1	0	1	8	ITA - Italy	2	0	2
Group E									
Rank	Team	Games	Wins	Losses					
1	ENG - England	2	2	0					
1	KOR - Korea	2	2	0					
3	RUS - Russia	1	1	0					
4	FIN - Finland	2	1	1					
5	AUT - Austria	1	0	1					
5	BEL - Belgium	1	0	1					
5	SUI - Switzerland	1	0	1					
8	FRA - France	2	0	2					

Note:
Under WCF rules, tie-breaking rules for standings are not applied until after the last game of the round robin.

Legend:
LSFE(*) Last Stone First End X Unplayed/unfinished end due to concession



SAT 12 OCT 2019
Start Time 16:00

Round Robin Session 3

Session Results and Standings

Sheet	Game	Team	LSFE	1	2	3	4	5	6	7	8	Extra Ends	Total
A	1	USA - United States	*	2	0	0	0	1	1	0	0		4
	1	ESP - Spain		0	1	0	1	0	0	2	3		7
B	1	NZL - New Zealand		0	1	0	0	0	2	1	X		4
	1	CZE - Czech Republic	*	3	0	3	1	1	0	0	X		8
C	1	DEN - Denmark		0	0	1	0	1	0	0	1		3
	1	NOR - Norway	*	2	1	0	1	0	1	1	0		6
D	1	AND - Andorra	*	1	0	2	0	0	0	0	X		3
	1	CRO - Croatia		0	1	0	1	1	2	1	X		6
E	1	WAL - Wales		0	0	1	0	0	1	0	X		2
	1	POL - Poland	*	0	2	0	2	0	0	1	X		5
F	1	AUS - Australia	*	1	0	1	0	2	0	1	0		5
	1	SWE - Sweden		0	2	0	4	0	0	0	2		8

Current Standings

Group A					Group B				
Rank	Team	Games	Wins	Losses	Rank	Team	Games	Wins	Losses
1	BLR - Belarus	1	1	0	1	CRO - Croatia	1	1	0
1	CAN - Canada	1	1	0	1	CZE - Czech Republic	1	1	0
1	EST - Estonia	1	1	0	1	NOR - Norway	1	1	0
1	SVK - Slovakia	1	1	0	1	POL - Poland	1	1	0
5	GER - Germany	1	0	1	5	AND - Andorra	1	0	1
5	HKG - Hong Kong	1	0	1	5	DEN - Denmark	1	0	1
5	KOS - Kosovo	1	0	1	5	NZL - New Zealand	1	0	1
5	NGR - Nigeria	1	0	1	5	WAL - Wales	1	0	1
Group C					Group D				
Rank	Team	Games	Wins	Losses	Rank	Team	Games	Wins	Losses
1	ESP - Spain	1	1	0	1	IRL - Ireland	1	1	0
1	HUN - Hungary	1	1	0	1	JPN - Japan	1	1	0
1	KAZ - Kazakhstan	1	1	0	1	SCO - Scotland	1	1	0
1	SWE - Sweden	1	1	0	4	ITA - Italy	1	0	1
5	AUS - Australia	1	0	1	4	LUX - Luxembourg	1	0	1
5	BRA - Brazil	1	0	1	4	SLO - Slovenia	1	0	1
5	LAT - Latvia	1	0	1		TPE - Chinese Taipei	0		
5	USA - United States	1	0	1		TUR - Turkey	0		
Group E									
Rank	Team	Games	Wins	Losses					
1	ENG - England	1	1	0					
1	FIN - Finland	1	1	0					
1	KOR - Korea	1	1	0					
4	AUT - Austria	1	0	1					
4	BEL - Belgium	1	0	1					
4	FRA - France	1	0	1					
	RUS - Russia	0							
	SUI - Switzerland	0							

Note:
Under WCF rules, tie-breaking rules for standings are not applied until after the last game of the round robin.

Legend:
LSFE(*) Last Stone First End X Unplayed/unfinished end due to concession



SAT 12 OCT 2019
Start Time 12:00

Round Robin Session 2

Session Results and Standings

Sheet	Game	Team	LSFE	1	2	3	4	5	6	7	8	Extra Ends	Total
A	1	IRL - Ireland		0	0	1	0	4	1	0	2		8
	1	SLO - Slovenia	*	1	2	0	1	0	0	1	0		5
B	1	ITA - Italy		1	0	1	0	0	0	X	X		2
	1	SCO - Scotland	*	0	3	0	1	2	1	X	X		7
C	1	LUX - Luxembourg		0	0	2	0	1	0	X	X		3
	1	JPN - Japan	*	2	2	0	1	0	6	X	X		11
D	1	BEL - Belgium		2	0	0	1	0	2	0	X		5
	1	FIN - Finland	*	0	3	3	0	3	0	3	X		12
E	1	FRA - France	*	1	0	0	2	0	1	0	1	0	5
	1	KOR - Korea		0	1	1	0	2	0	1	0	1	6
F	1	ENG - England		1	1	2	0	0	3	0	X		7
	1	AUT - Austria	*	0	0	0	1	2	0	1	X		4

Current Standings

Group A					Group B				
Rank	Team	Games	Wins	Losses	Rank	Team	Games	Wins	Losses
1	BLR - Belarus	1	1	0		AND - Andorra			
1	CAN - Canada	1	1	0		CRO - Croatia			
1	EST - Estonia	1	1	0		CZE - Czech Republic			
1	SVK - Slovakia	1	1	0		DEN - Denmark			
5	GER - Germany	1	0	1		NOR - Norway			
5	HKG - Hong Kong	1	0	1		NZL - New Zealand			
5	KOS - Kosovo	1	0	1		POL - Poland			
5	NGR - Nigeria	1	0	1		WAL - Wales			
Group C					Group D				
Rank	Team	Games	Wins	Losses	Rank	Team	Games	Wins	Losses
1	HUN - Hungary	1	1	0	1	IRL - Ireland	1	1	0
1	KAZ - Kazakhstan	1	1	0	1	JPN - Japan	1	1	0
3	BRA - Brazil	1	0	1	1	SCO - Scotland	1	1	0
3	LAT - Latvia	1	0	1	4	ITA - Italy	1	0	1
	AUS - Australia	0			4	LUX - Luxembourg	1	0	1
	ESP - Spain	0			4	SLO - Slovenia	1	0	1
	SWE - Sweden	0				TPE - Chinese Taipei	0		
	USA - United States	0				TUR - Turkey	0		
Group E									
Rank	Team	Games	Wins	Losses					
1	ENG - England	1	1	0					
1	FIN - Finland	1	1	0					
1	KOR - Korea	1	1	0					
4	AUT - Austria	1	0	1					
4	BEL - Belgium	1	0	1					
4	FRA - France	1	0	1					
	RUS - Russia	0							
	SUI - Switzerland	0							

Note:
Under WCF rules, tie-breaking rules for standings are not applied until after the last game of the round robin.

Legend:
LSFE(*) Last Stone First End X Unplayed/unfinished end due to concession



SAT 12 OCT 2019
Start Time 8:00

Round Robin Session 1

Session Results and Standings

Sheet	Game	Team	LSFE	1	2	3	4	5	6	7	8	Extra Ends	Total
A	1	BRA - Brazil		0	1	0	1	0	0	X	X		2
	1	HUN - Hungary	*	4	0	5	0	3	2	X	X		14
B	1	BLR - Belarus	*	1	1	0	1	0	0	1	2		6
	1	HKG - Hong Kong		0	0	2	0	1	1	0	0		4
C	1	CAN - Canada		0	0	0	2	2	0	0	2		6
	1	GER - Germany	*	0	1	1	0	0	1	0	0		3
D	1	EST - Estonia		4	2	3	1	2	0	4	X		16
	1	NGR - Nigeria	*	0	0	0	0	0	1	0	X		1
E	1	SVK - Slovakia											W
	1	KOS - Kosovo											L
F	1	LAT - Latvia	*	0	1	0	0	2	0	2	X		5
	1	KAZ - Kazakhstan		3	0	3	2	0	4	0	X		12

Current Standings

Group A					Group B				
Rank	Team	Games	Wins	Losses	Rank	Team	Games	Wins	Losses
1	BLR - Belarus	1	1	0		AND - Andorra			
1	CAN - Canada	1	1	0		CRO - Croatia			
1	EST - Estonia	1	1	0		CZE - Czech Republic			
1	SVK - Slovakia	1	1	0		DEN - Denmark			
5	GER - Germany	1	0	1		NOR - Norway			
5	HKG - Hong Kong	1	0	1		NZL - New Zealand			
5	KOS - Kosovo	1	0	1		POL - Poland			
5	NGR - Nigeria	1	0	1		WAL - Wales			
Group C					Group D				
Rank	Team	Games	Wins	Losses	Rank	Team	Games	Wins	Losses
1	HUN - Hungary	1	1	0		IRL - Ireland			
1	KAZ - Kazakhstan	1	1	0		ITA - Italy			
3	BRA - Brazil	1	0	1		JPN - Japan			
3	LAT - Latvia	1	0	1		LUX - Luxembourg			
	AUS - Australia	0				SCO - Scotland			
	ESP - Spain	0				SLO - Slovenia			
	SWE - Sweden	0				TPE - Chinese Taipei			
	USA - United States	0				TUR - Turkey			
Group E									
Rank	Team	Games	Wins	Losses					
	AUT - Austria								
	BEL - Belgium								
	ENG - England								
	FIN - Finland								
	FRA - France								
	KOR - Korea								
	RUS - Russia								
	SUI - Switzerland								

Legend:			
L	Loss	LSFE(*)	Last Stone First End
X	Unplayed/unfinished end due to concession	W	Win

KOS forfeits the game as only two players were present to start the competition

Entry List by Country

As of MON 14 OCT 2019

AND - Andorra		Group B	
4 S	GARCIA Josep	M	R
3 V	ARCE Ana	F	R
2	ORTIZ Valentin	M	R
1	FOWLER Lisa Anne	F	R
C	-		
O	-		

AUS - Australia		Group C	
4 S	MILLIKIN Hugh	M	R
3 V	FORGE Kim	F	R
2	JOHNS Steve	M	R
1	POWELL Anne	F	R
C	-		
O	-		

AUT - Austria		Group E	
4 S	UNTERBERGER Andreas	M	R
3 V	WITSCHEN Jill	F	R
2	HIGATZBERGER Gernot	M	R
1	HOESS Johanna	F	R
C	SCHROEDER Bjoern (GER)		
O	-		

BEL - Belgium		Group E	
4 V	HEYLEN Dirk	M	L
3	BERUS Danielle	F	R
2	VANDERMEEREN Stephane	M	R
1 S	GEERINCKX Veerle	F	R
C	-		
O	-		

BLR - Belarus		Group A	
4 S	PAULIUCHYK Alina	F	R
3 V	BARKAN Dmitriy	M	R
2	DZIASHUK Marharyta	F	R
1	BURMISTRAU Vitali	M	R
C	ORLOV Aleksandr (RUS)		
O	-		

BRA - Brazil		Group C	
4 S	VILELA Sergio Mitsuo	M	R
3 V	BARROS Alessandra	F	R
2	RODRIGUES Marcio	M	R
1	YANG Samanta	F	L
C	SARTI Bruno		
O	VERGNIASSI VILELA Daniela		

CAN - Canada		Group A	
4 S	KURZ Colin	M	R
3 V	WALTER Meghan	F	R
2	BILAWKA Brendan	M	R
1	OLIVER Sara	F	R
C	WAITE Jim		
2C	CLASPER Tom		

CRO - Croatia		Group B	
4 S	SKENDROVIC Alberto	M	R
3 V	MUHEK Zrinka	F	R
2	DZEPINA Davor	M	R
1	SIMUNJAK Marija	F	R
C	-		
O	-		

CZE - Czech Republic		Group B	
4 V	MIKLIK Dalibor	M	R
3 S	MIKLIKOVA Eva	F	R
2	MOKRIS Samuel	M	R
1	MOKRISOVA Martina	F	R
C	-		
O	-		

DEN - Denmark		Group B	
4 S	THUNE Tobias	M	R
3 V	LANDER Jasmin	F	R
2	HOLTERMANN Henrik	M	R
1	LARSEN My	F	R
C	-		
O	-		

ENG - England		Group E	
4 V	BRAND Stuart	M	R
3 S	SPAIN Fiona	F	R
2	HAVERCROFT Jonathan	M	R
1	SPAIN Kathryn	F	R
C	PAUL Elizabeth		
O	-		

ESP - Spain		Group C	
4 S	VEZ Sergio	M	R
3 V	OTAEGI Oihane	F	R
2	UNANUE Mikel	M	R
1	OTAEGI Leire	F	R
C	-		
O	-		

EST - Estonia		Group A	
4 S	LILL Erkki	M	R
3 V	MADISSON Triin	F	R
2	VLASSOV Mihhail	M	R
1	ELMIK Kaidi	F	R
C	-		
O	-		

FIN - Finland		Group E	
4 S	SIPILA Markus	M	R
3	IMMONEN Lotta	F	R
2	OUNI Leo	M	R
1 V	SUURIPAA Tiina	F	R
C	KUOSMANEN Paavo		
O	NILHAMN Bonnie (NED)		

Entry List by Country

As of MON 14 OCT 2019

FRA - France		Group E	
4 S	VERGNAUD Stephane	M	R
3	LAFAGE Eva	F	L
2	VERGNAUD Laurent	M	R
1 V	LAGREE Celine	F	R
C	-		
O	-		

GER - Germany		Group A	
4 S	KAPP Andy	M	R
3	SCHOELL Pia-Lisa	F	R
2	KAPP Benny	M	R
1 V	TSCHETSCH Petra	F	R
C	-		
O	-		

HKG - Hong Kong		Group A	
4 S	CHANG Jason	M	R
3 V	HUNG Ling-Yue	F	R
2	YAN Martin	M	R
1	WONG Ashura	F	R
C	COLLINS Rick (CAN)		
2C	MORRISON Julie (SCO)		

HUN - Hungary		Group C	
4 S	NAGY Gyorgy	M	L
3	SZEKERES Ildiko	F	R
2	SZABO Gergely	M	R
1 V	DENCSE Blanka	F	R
C	WATSON Karen (CAN)		
O	-		

IRL - Ireland		Group D	
4 S	WILSON John	M	R
3 V	ANDERSON Ailsa	F	R
2	WHYTE Craig	M	R
1	BEGLEY LUKE Niamh	F	R
C	HIBBERD David		
O	-		

ITA - Italy		Group D	
4 V	SOLA Fabio	M	R
3 S	PIMPINI Denise	F	R
2	GENRE Julien Michele	M	R
1	ALIBERTI Sara	F	R
C	-		
O	-		

JPN - Japan		Group D	
4 S	MAEDA Takumi	M	R
3 V	TABATA Momoha	F	R
2	NAKAHARA Asei	M	R
1	KOBAYASHI Mina	F	R
C	OGASAWARA Ayumi		
O	YANAGI Hitoshi		

KAZ - Kazakhstan		Group C	
4 V	ALLIYAROVA Sitora	F	R
3 S	ZHUZBAY Abylaikhan	M	R
2	-		
1	EBAUYER Angelina	F	R
C	-		
O	-		

KOR - Korea		Group E	
4 S	SEONG Yujin	M	R
3 V	JANG Hyeji	F	R
2	JEON Jaeik	M	R
1	SONG Yujin	F	R
C	AHN Jaesung		
O	-		

KOS - Kosovo		Group A	
4 S	ANDERSEN Peter	M	R
3 V	DAKAJ Eldena	F	R
2	SHABAJ Eric	M	R
1	SHATRI Mirjeta	F	R
C	ZENELI Meriton		
2C	RUSSELL Judy (CAN)		

LAT - Latvia		Group C	
4 V	RUDZITIS Janis	M	R
3 S	RUDZITE Jelena	F	R
2	PETERSONS Didzis	M	L
1	SPILNERE-PUCINA Dace	F	R
C	PETERSONE Anita		
O	-		

LUX - Luxembourg		Group D	
4 S	BENOY Alex	M	R
3 V	WAUTERS Karen	F	R
2	HUSI Marc	M	R
1	BENOY Susi	F	R
C	-		
O	-		

NGR - Nigeria		Group A	
4 S	COLE Tijani	M	L
3 V	COLE Susana	F	R
2	WOODS III Harold	M	R
1	COLE-STREHLOW Carolay	F	R
C	GUMLEY Vicky (SCO)		
O	-		

NOR - Norway		Group B	
4 V	NAESS Wilhelm	M	R
3 S	SKAGA Ingvild	F	R
2	SKARSHEIM RIAN Harald	M	R
1	MESLOE Eirin	F	R
C	RIAN Stale		
O	-		

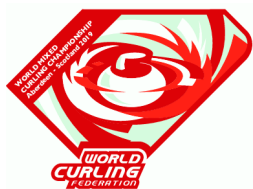

Competition Officials

As of FRI 11 OCT 2019

Function	Name	Organisation
WCF President:	CAITHNESS Kate	SCO - Scotland
WCF Head of Competitions:	ROETHLISBERGER Eeva	SUI - Switzerland
WCF Technical Delegate:	WILLMS Karri	CAN - Canada
Chief Ice Technician:	MARTIN Paul	SCO - Scotland
Deputy Chief Ice Technician:	McLACHLAN Stuart	SCO - Scotland
Chief Umpire:	MELROSE Colin	SCO - Scotland
Deputy Chief Umpire:	BARROWMAN Glenda	ENG - England
Game Umpires:	MALCOLM Marion	SCO - Scotland
	MIDDLER Albert	SCO - Scotland
	PETERS Lisa	WAL - Wales
	SMITH Lorna	SCO - Scotland
Chief Timer:	YEATS Brian	SCO - Scotland
Deputy Chief Timer:	STANLEY Graham	SCO - Scotland

Competition Schedule

As of THU 10 OCT 2019

Date	Start Time	Session	Sheet A	Sheet B	Sheet C	Sheet D	Sheet E	Sheet F
SAT 12 OCT	8:00	1	BRA - HUN	BLR - HKG	CAN - GER	EST - NGR	SVK - KOS	LAT - KAZ
	12:00	2	IRL - SLO	ITA - SCO	LUX - JPN	BEL - FIN	FRA - KOR	ENG - AUT
	16:00	3	USA - ESP	NZL - CZE	DEN - NOR	AND - CRO	WAL - POL	AUS - SWE
	20:30	4	KOR - FIN	SUI - RUS	ENG - FRA	IRL - ITA	TPE - TUR	SCO - JPN
SUN 13 OCT	8:00	5	POL - DEN	CRO - WAL	USA - BRA	NOR - NZL	SWE - ESP	CZE - AND
	12:00	6	KOS - NGR	HUN - KAZ	LAT - AUS	SVK - GER	HKG - EST	CAN - BLR
	16:00	7	SCO - LUX	SLO - TUR	IRL - TPE	FIN - FRA	AUT - RUS	KOR - BEL
	20:00	8	AND - NZL	CZE - NOR	JPN - ITA	ENG - SUI	POL - CRO	DEN - WAL
MON 14 OCT	8:00	9	AUS - KAZ	AUT - BEL	HUN - SWE	USA - LAT	SLO - LUX	
	12:00	10	ITA - TPE	JPN - IRL	RUS - KOR	TUR - SCO	FIN - ENG	FRA - SUI
	16:00	11	BLR - GER	DEN - AND	SVK - CAN	NGR - HKG	BRA - KAZ	EST - KOS
	20:00	12	HUN - USA	AUS - ESP	NOR - CRO	POL - CZE	NZL - WAL	SWE - LAT
TUE 15 OCT	8:00	13	ENG - RUS		KOR - SUI	SCO - TPE		IRL - TUR
	12:00	14	CRO - CZE	USA - SWE	NZL - DEN	WAL - AND	LAT - HUN	NOR - POL
	16:00	15	TPE - JPN	FRA - AUT	TUR - LUX	RUS - BEL	ITA - SLO	SUI - FIN
	20:00	16	HKG - CAN	EST - BLR	KAZ - ESP	BRA - AUS	KOS - GER	NGR - SVK
WED 16 OCT	8:00	17	FRA - BEL	POL - NZL	CZE - WAL	CRO - DEN	NOR - AND	ITA - LUX
	12:00	18	SUI - AUT	HKG - SVK	GER - EST	BLR - KOS	CAN - NGR	TPE - SLO
	16:00	19	ESP - LAT	RUS - FIN	BEL - ENG	LUX - IRL	TUR - JPN	HUN - AUS
	20:00	20	SWE - BRA	GER - NGR	SLO - SCO	AUT - KOR	BLR - SVK	KAZ - USA
THU 17 OCT	8:00	21		LUX - TPE	HKG - KOS	CAN - EST	BEL - SUI	NZL - CRO
	12:00	22	WAL - NOR	KOR - ENG	AND - POL	JPN - SLO	DEN - CZE	ESP - BRA
	16:00	23	EST - SVK	KOS - CAN	NGR - BLR	KAZ - SWE	AUS - USA	GER - HKG
	20:00	24	TUR - ITA	BRA - LAT	FIN - AUT	ESP - HUN	SCO - IRL	RUS - FRA
FRI 18 OCT	9:00	1/8 Finals Session 1						
	13:00	1/8 Finals Session 2						
	19:00	Quarter-finals						
SAT 19 OCT	9:00	Semi-finals						
	15:00	Finals						

Note:

First named team in each game plays red-handled stones and wears dark coloured upper playing garments.